

KOSMOS SERIES

CODE: 30727007 EDITION: 12-07-2010



MODEL ALPHA-C

INSTRUMENT FOR USE WITH LOAD CELL



FIRMWARE
2.00
VERSION

MOD
BUS

FAIL
SAFE

SENSOR
BREAK
ALARM



FIRMWARE
2.00
VERSION

Firmware Version 2.00

**MOD
BUS**

Modbus Compatible
See page 44

**FAIL
SAFE**

Fail Safe Function
See page 42

**SENSOR
BREAK
ALARM**

Sensor Break Alarm
See page 29

36

36 Logical functions
See page 33



Blinking Display
See page 41



Programming parameters lockout
See page 38



Factory defaults
See page 43



Linearization by segments
See page 16

TARE

3 Tare modes
See page 26

INTRODUCTION TO THE KOSMOS SERIES

This manual does not constitute a formal agreement. All information given in this manual is subject to change without notice.

The KOSMOS SERIES brings a new philosophy in digital panel instrumentation which is expressed by multipurpose, modular-concept devices providing a rich array of basic functions and advanced capabilities.

With a fully MODULAR DESIGN, it is possible to implement a wide variety of applications by only adding the adequate options.

Intelligence within it allows the instrument to recognize the options installed and ask for the necessary parameters to properly function within desired margins. The parameters related to non-installed options are removed from the program routines.

The instrument's CALIBRATION is made at the factory eliminating the need for adjustment potentiometers. Any circuit or option liable to be adjusted incorporates a memory where calibration parameters are stored, making it possible the optional cards be totally interchangeable without need of any subsequent adjust.

Custom CONFIGURATION for specific applications can be made quickly and easily through five front panel keys, following structured choice menus aided by display prompts at each programming step.

Other features of the KOSMOS family include:

- CONNECTIONS via plug-in terminal blocks without screws and CLEMP-WAGO clips cable retention system
- DIMENSIONS
Models ALPHA & BETA 96x48x120 mm DIN 43700
Models MICRA & JR/JR20 96x48x60 mm DIN 43700
- CASE MATERIAL UL-94 V0-rated polycarbonate.
- PANEL INSTALLATION without screws by means of single part fastening clips

To guarantee the meter's technical specifications, it is recommended to recalibrate the meter at periodical intervals according to the ISO9000 standards for the particular application operating criteria. Calibration should be performed at the factory or in a qualified laboratory.

INDEX

1 . MODEL ALPHA-C OVERVIEW	6
1.1. - KEYBOARD AND DISPLAY DESCRIPTION	7
2 . GETTING STARTED.....	9
2.1 - POWER / CONNECTORS.....	10
2.2 - INTRODUCTION TO THE PROGRAMMING MODE	12
2.3 - INPUT CONFIGURATION.....	14
2.4 - DISPLAY CONFIGURATION	16
2.5 – PROGRAMMING NET VALUE TARE MODE 3	28
3 . KEYBOARD AND CONNECTORS CONTROLS	
3.1 - KEYBOARD FUNCTIONS.....	30
3.2 - CONNECTORS FUNCTIONS	32
3.3 - TABLE OF PROGRAMMABLE FUNCTIONS	33
3.4 - LOGIC INPUTS PROGRAMMING.....	36
3.5 - PROGRAMMING LOCK OUT. ACCESS LEVELS.....	38
4 . OUTPUT OPTIONS	39
4.1 - ADDED OUTPUT FUNCTIONS	41
5 . TECHNICAL SPECIFICATIONS	45
5.1 - DIMENSIONS AND MOUNTING.....	46
6 . WARRANTY	47
7 . DECLARATION OF CONFORMITY.....	48

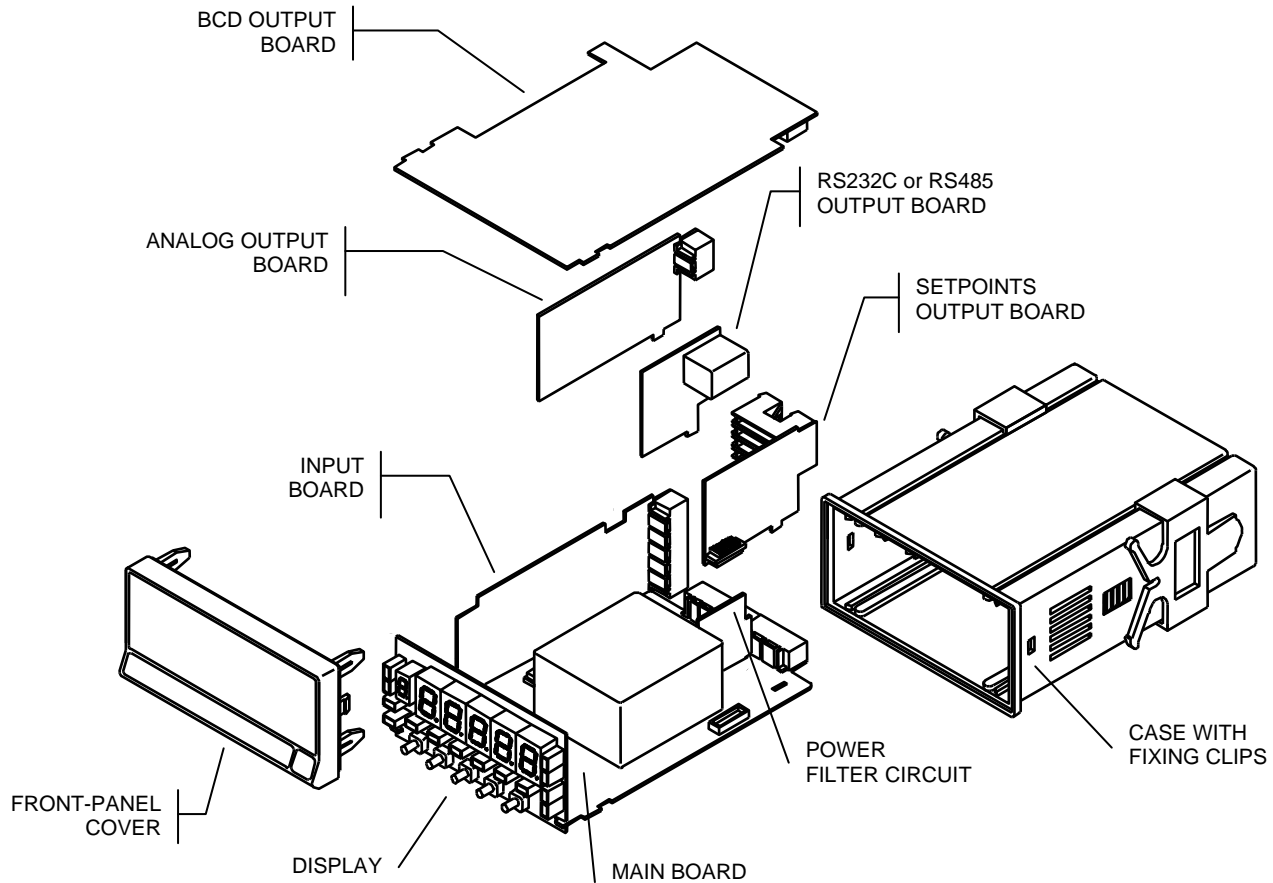

1. MODEL ALPHA-C OVERVIEW

The ALPHA-C model incorporates new technical and functional characteristics including ± 32000 count display, signal linearization of up to 30 points and user programmable remote logic functions that provides an extraordinary flexibility to adapt to a wide range of indication and control needs.

The model ALPHA-C of the KOSMOS series is a digital indicator designed to measure forces (weight, load, torque, pressure ...) that admits connection of several bridges such as load-cells with small signal levels up to ± 300 mV.

It provides four selectable input ranges (± 15 mV, ± 30 mV, ± 60 mV or ± 300 mV) and two excitation voltages (5 V or 10 V) that allow accommodating different cell types and inputting sensitivities. Two programming modes permit scaling the meter to fit the desired units for specific applications.

The meter has two input filtering methods with selectable levels and selectable resolution to help stabilizing the display according to the process type.

The basic instruments is a soldered assembly composed of the MAIN BOARD, the DISPLAY and the power FILTERING circuit and the INPUT card that are located in their corresponding plug-in connectors (see figure in page 5). Standard features of the basic instrument include the reading of the input variable, max and min detection, remote hold operation, tare function and reset and a full complement of programmable logic functions.

In addition, a variety of plug-in output cards can be installed at any time to meet further system requirements:

COMMUNICATION

RS2	Serie RS232C
RS4	Serie RS485
BCD	BCD 24 V/ TTL

CONTROL

ANA	Analogical 4-20 mA, 0-10 V
2RE	2 SPDT relays 8 A
4RE	4 SPST relays 5 A*
4OP	4 NPN outputs
4OPP	4 PNP outputs

All the outputs are isolated with respect to the input signal and supply.

* From n° 05397



This instrument conforms to the following directives: EMC 2004/108/CEE and LVD 2006/95/CEE
Caution: Read complete instructions to ensure safety protections.

FRONT-PANEL FUNCTIONS IN RUN MODE

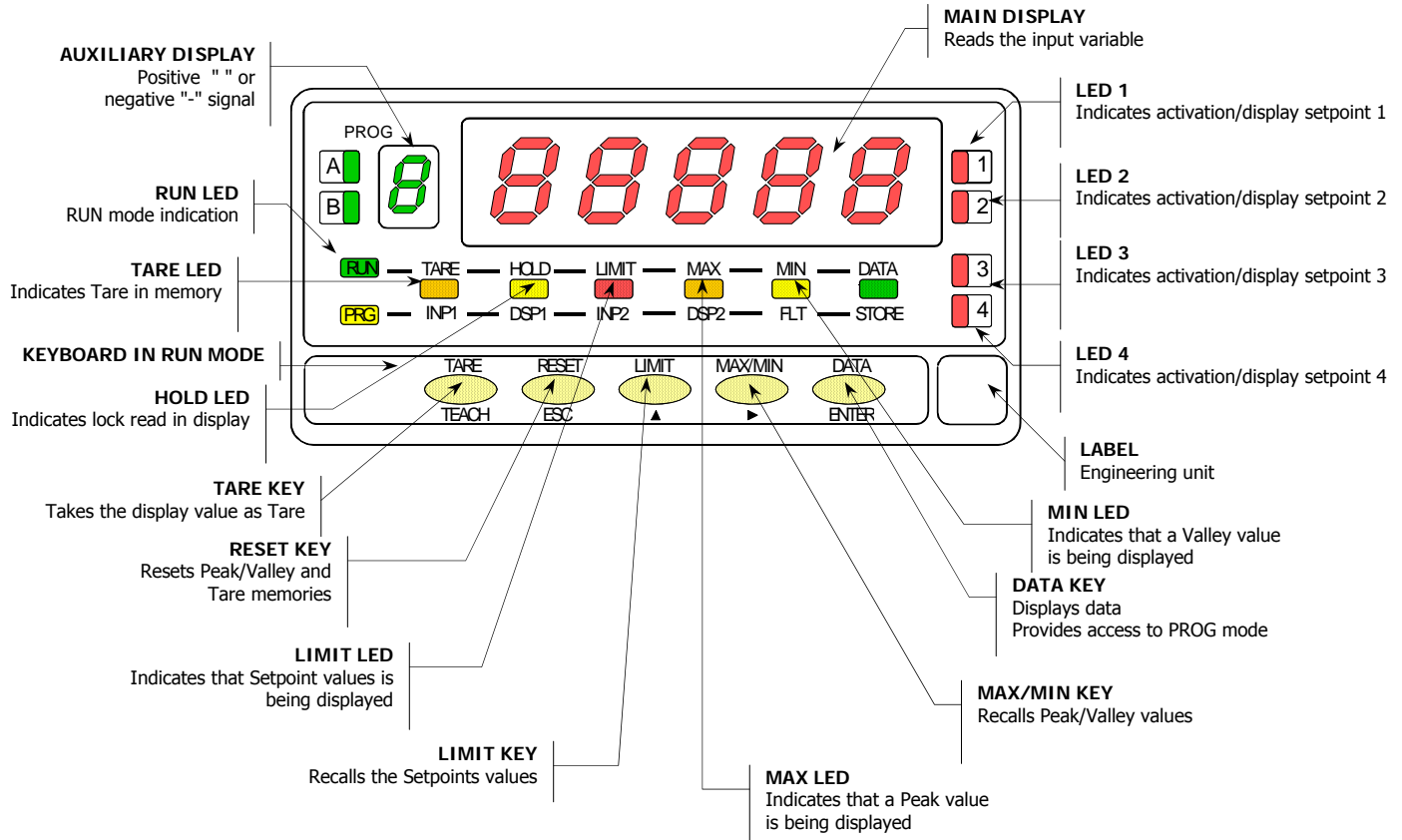

FRONT-PANEL FUNCTIONS IN PROG MODE

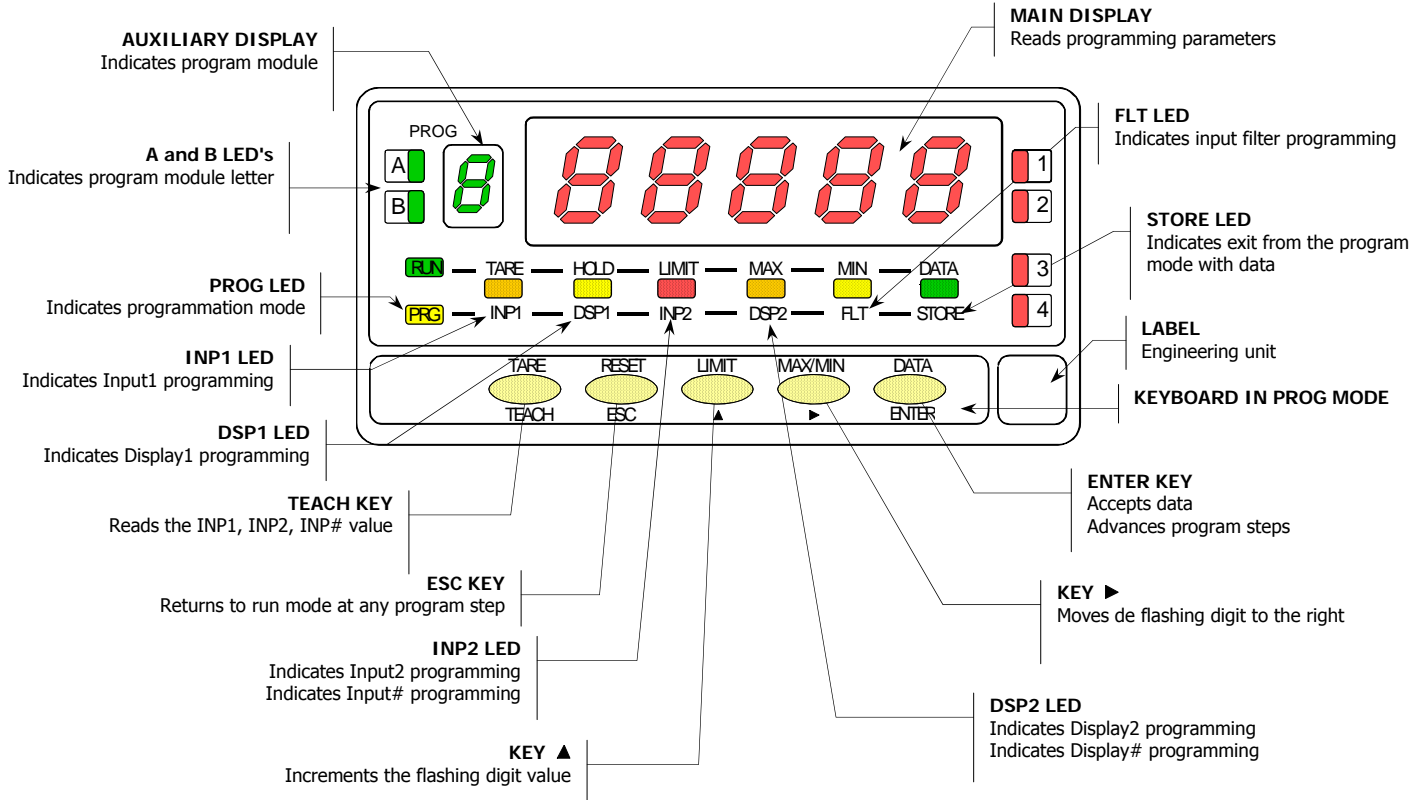

2. GETTING STARTED

PACKAGE CONTENTS

- ❑ Instructions manual in English including Declaration of Conformity.
- ❑ D.P.M. model Alpha-C2.00.
- ❑ Accessories for panel mounting (sealing gasket and fastening clips).
- ❑ Accessories for wiring connections (removable plug-in connectors and fingertip).
- ❑ Wiring label stuck to the Alpha-C case.
- ❑ Two sets of engineering units labels.

✓ *Check the package contents.*

CONFIGURATION

Power supply (page 9 and 10)

- ❑ Instruments supplied for 115/ 230 V AC power are factory set for 230 V AC (USA market 115 V AC).
- ❑ Instruments supplied for 24/ 48 V AC power are factory set for 24 V AC.
- ❑ Instruments supplied for 10-30 V DC can be powered from any voltage between 10 and 30 V DC without need of making changes.

✓ *Check the wiring label before power connection.*

Programming instructions (page 11 and 12)

- ❑ The software is divided into several independently accessible modules to configure the input, the display, the setpoints, the analogical output, the output communication and logic inputs.

✓ *Read carefully this section.*

Input type (page 13 and 14)

- ❑ The instrument provides two excitation voltages to supply the transducer (5 V or 10 V). The instrument is set up at factory to 10 V.
- ❑ The maximum voltage applicable to the instrument is 300 mV. There are four available input ranges: 15 mV, 30 mV, 60 mV and 300 mV.

✓ *Check the cell sensitivity. If you have any doubt please consult the cell specifications.*

Programming Lock-out (page 33)

- ❑ The instrument is set at the factory with the program routines totally accessible.

Warning! Keep your unlock code in a secure place. If you lost it, it is possible to reset it (page 36).

2.1 - POWER SUPPLY

Should any hardware modification be performed, remove the electronics from the case as shown in figure 9.1.

115/230 V AC: The instruments with 115/230 V AC power, are shipped from the factory for 230 V AC (USA market 115 V AC), see figure 9.2. To change supply voltage to 115 V AC, set jumpers as indicated in figure 9.3 (see table 1). The wiring label should be modified to match new setups.

24/48 V AC: The instruments with 24/48 V AC power supply, are shipped from the factory for 24 V AC, see figure 9.3 To change supply voltage to 48 V AC, set jumpers as indicated in figure 9.2 (see table 1). The wiring label should be modified to match new setups.

10-30V DC: The instruments for 10-30V DC power supply are prepared to withstand any voltage between 10 and 30V without need of wiring changes.

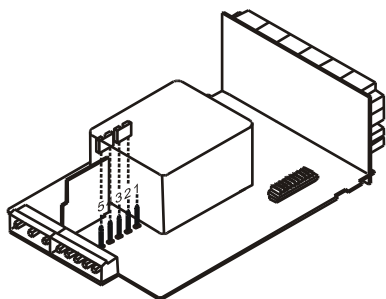

Fig. 10.2. Supply voltage 230 V or 48 V AC

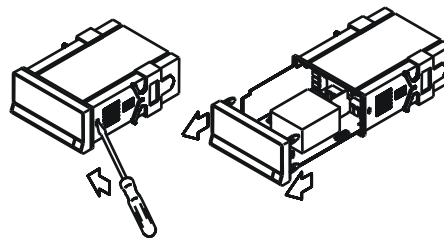

Fig. 10.1. Removing the case

Tabla 1. Jumper settings.

Pin	1	2	3	4	5
230V AC	-	■	■	■	■
115V AC	■	■	■	■	-
48V AC	-	■	■	■	■
24V AC	■	■	■	■	-

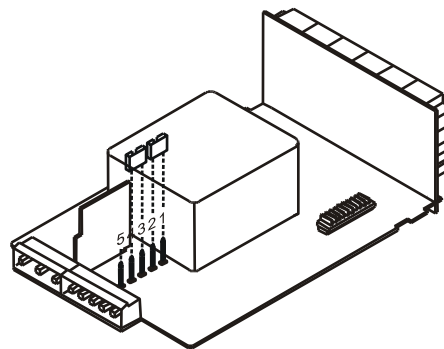
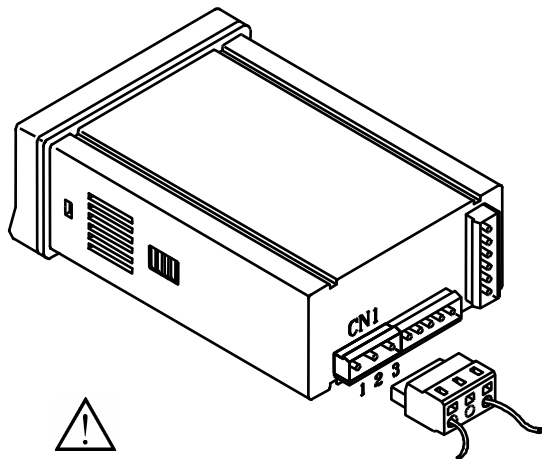

Fig. 10.3. Supply voltage 115 V or 24 V AC

POWER CONNECTION



AC VERSIONS

PIN 1 - AC HI

PIN 2 - GND (GROUND)

PIN 3 - AC LO (NEUTRAL)

DC VERSIONS

PIN 1 - DC POSITIVE

PIN 2 - N/C (no connection)

PIN 3 - DC NEGATIVE

INSTALLATION

To meet the requirements of the directive EN61010-1, where the unit is permanently connected to the mains supply it is obligatory to install a circuit breaking device easily reachable by the operator and clearly marked as the disconnect device.

WARNING

In order to guarantee electromagnetic compatibility, the following guidelines for cable wiring must be followed:

- Power supply wires must be routed separated from signal wires. *Never* run power and signal wires in the same conduit.
- Use shielded cable for signal wiring and connect the shield to ground of the indicator (pin2 CN1).
- The cable section must be $\geq 0.25 \text{ mm}^2$

If not installed and used according to these instructions, protection against hazards may be impaired.

CONNECTORS

To perform wiring connections, remove the terminal block from the meter's connector, strip the wire leaving from 7 to 10 mm exposed and insert it into the proper terminal while pushing the fingertip down to open the clip inside the connector as indicated in the figure.

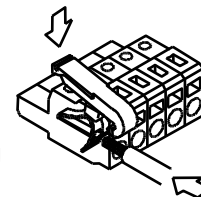

Proceed in the same manner with all pins and plug the terminal block into the corresponding meter's connector.

Each terminal can admit cables of section comprised between 0.08 mm^2 and 2.5 mm^2 (AWG 26 ÷ 14).

The blocks provide removable adaptors into each terminal to allow proper fastening for cable sections of $<0.5 \text{ mm}^2$.

2.2 - PROGRAMMING INSTRUCTIONS

Connect the instrument to the main supply. During a short period of time the digits, the decimal point and LEDs will turn on as a verification of the correct function of the instrument. After that the display will show the firmware version for 2 seconds. Example: C2.00

Press **ENTER** key to enter the programming mode and in the display will appear the indication -Pro-. The programming routine is divided in independent access modules that appear by pressing **▶** key from the -Pro- level in the following order:

7. *Cni nP* = Input configuration.
8. *CndSP* = Display configuration.
9. *SEtP* = Setpoints.
10. *AnoUt* = Analog output.
11. *rSoUt* = RS output.
12. *Lo9 in* = Logical inputs.

The 3, 4 and 5 modules will be bypassed if the output options are not installed. The information related to its programming can be found in its own manual.

In the figure you can see how to enter the programming mode, the module selection level and the exit with or without saving data. Once in the display the desired module indication, the access to the different settings menu has to be done by pressing **ENTER** key.

In the global diagrams like the one in the picture, it is shown the procedure of the programming.

Reading the diagram left to right **▶** key represents selection or displacement. Reading the diagram up to down **ENTER** key represents the data input and advance.

ESC key put the instrument in run mode from any step of the programming without saving changes.

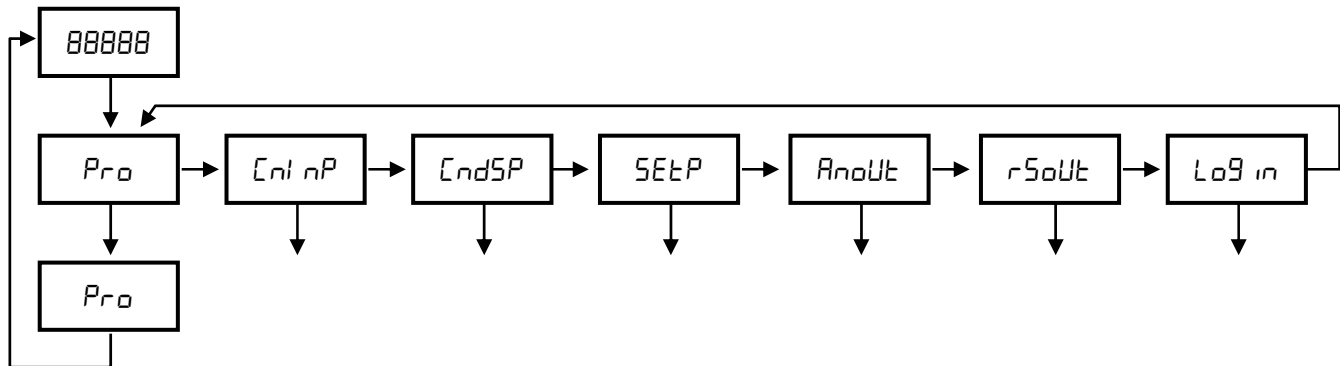

The programming instructions are composed by a general description and a series of step-by-step instructions to be followed sequentially. Each menu step is represented by an illustration of the display and keyboard module with indicators (display and LED's), reference [page number. figure number] and a text describing the action of each key at that step.

[Page n°/figure n°] Mnemo

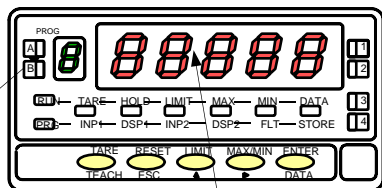

Program module and menu step indicators

In the step-by-step instructions, you are given the action of the three buttons mainly used to program data. The normal procedure at each step is to push on a number of times to make changes and push on to validate changes and advance to the next programming step. At the end of a complete menu sequence the meter returns to the run mode saving changes in memory.

In general the following actions can be made during the program mode.

- validate changes and advance to next step
- discard changes and go to the run mode
- select among a list of available options / shift to next digit to the right
- increment digit value

With respect to the figures in the step-by-step instructions, the display indications may have the following meanings:

- 1./ The display shows one of the available options with filled-out segments. That means that the display shows the choice made previously. The use of allows to select from available options.
- 2./ A series of black "8" also represents the display indication of a previous choice, with the difference that it cannot be changed in the current step. If it is already the desired parameter, you may exit from the menu by a push of without making changes or, if wanted to modify it, a push of advances the meter to the next step where changes are allowed.
- 3./ A series of white "8" represents any numerical value that is programmed by using keys (Increment digit value) and (advance to the next digit).

2.3 - INPUT CONFIGURATION

To completely configure the input of the load-cell indicator, it will be necessary to act on these two parameters:

1. Excitation voltage selection.

The indicator provides two excitation voltages to supply the transducer; 5 V or 10 V. The selection is made by means of a plug-in jumper located behind the input card connector. Refer to the figure 13.1 to locate the jumper positions.

2. Input connection

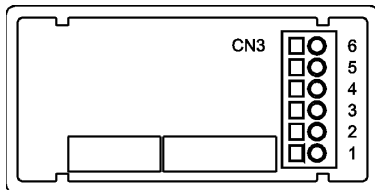

PIN 6 = -EXC
 PIN 5 = +EXC
 PIN 4 = N/C
 PIN 3 = -mV
 PIN 2 = N/C
 PIN 1 = +mV (max. 300 mV)

Fig. 14.1: excitation jumper

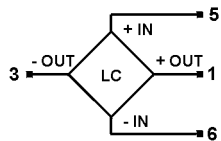
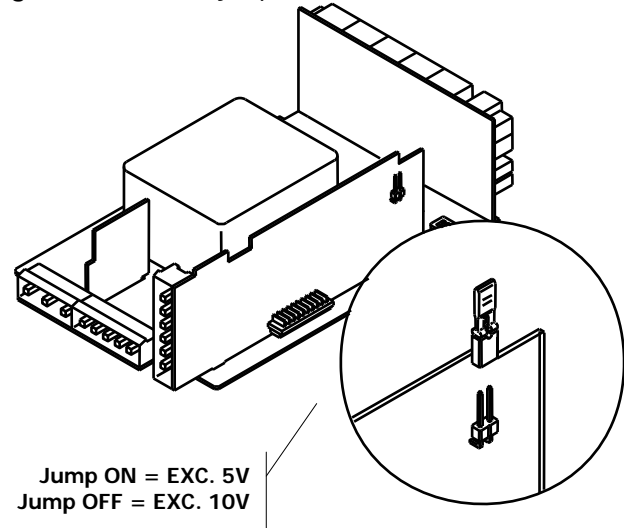

LOAD-CELL

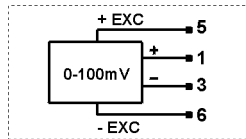

TRANSDUCER 0-100mV

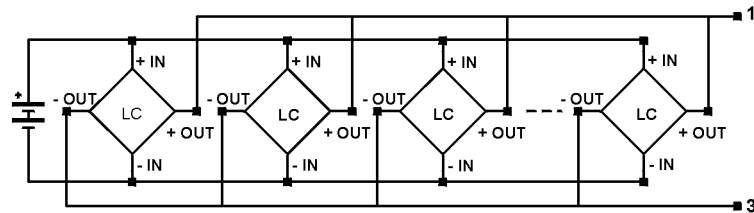

4 OR MORE CELLS CONNECTED IN PARALLEL

3. Input programming range.

The only configurable parameter is the input range. There are four available ranges; 15 mV, 30 mV, 60 mV or 300 mV which are to be chosen to match the cell sensitivity (max. output in mV). The maximum voltage applicable to the instrument is 300 mV. The built-in excitation voltage can be used to power up to 4 cells connected in parallel, with 10 V excitation and up to 8 cells with 5 V excitation. Suppose 4 cells with 2 mV per Volt output that are powered from the 10 V excitation source so each one drives out 20 mV. Since they are connected in parallel, the total output voltage is 20 mV. For this configuration the instrument should be programmed for an input range of 30 mV.

After deciding the input range, we are ready to enter in the input configuration module (1 CnInP) to program this parameter. Connect the instrument to the power supply. For a few seconds, the display will illuminate all segments, decimal points and LED's as a test of their proper operation.

[15.1] Input configuration

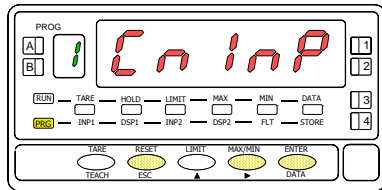

From the run mode, press **ENTER** to get access to the programming mode (the -Pro- indication appears on the display). Press the **▶** key to make the display show the indication given by the figure 14.1. that corresponds to the entry into the input programming module.

- ENTER** Access input range configuration
- ▶** To skip over this stage.
- ESC** To exit from programming mode and return the meter to the run mode.

[15.2] Input range

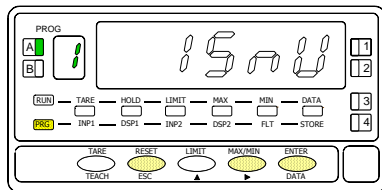

The display shows the previously-selected input range. If it is already the desired one, press **ESC** to return to the run mode. To modify this parameter, press repeatedly the **▶** key until the desired input range ["15mV", "30mV", "60mV" or "300mV"] appears on the display.

- ENTER** To save the entry in the memory and go to the run mode.
- ESC** Cancel programming and return to run mode

2.4 - DISPLAY CONFIGURATION

After selection of the input range, it may be necessary to scale the instrument for the particular application. For many common applications, single slope scaling (2 points) should be sufficient to have good readings over the entire process range. Other applications, in which non-linear devices are used may require linearizing the signal. This is accomplished by scaling the meter with more than two points (see fig. 16.1)

Type of function	N° of scaling points
Linear function	2 points
Non-linear function	Max 30 points

1. Scaling the display.

The procedure of scaling the display consists of programming a minimum of two points composed each by an input (INP#) and a display (DSP#) coordinates.

When scaling the meter with two points (linear function), they should be located near the process limits for the best possible accuracy.

For multi-point scaling, it is recommended to use the most possible number of points and to reduce the segment length. **The input signal values of the scaling points must be all increasing or all decreasing. Avoid programming two different displays for two equal inputs.** The display values can be entered in any order and even be repeated for two or more input values.

Fig. 16.1: *Linearizing function with 6 segments (7 points).*

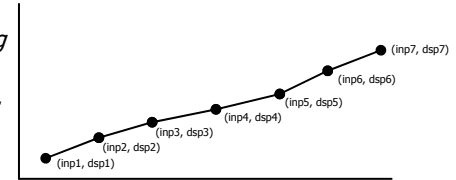

2. Action modes

The figure below represents two modes of operation

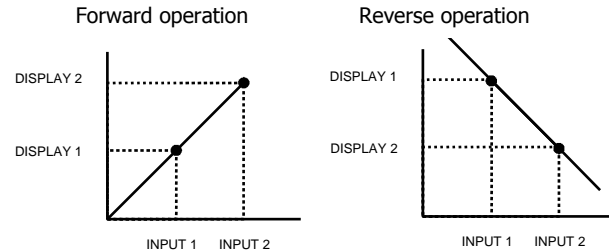

Forward operation:

- When input signal *increases*, the display *increases*.
- When input signal *decreases*, the display *decreases*.

Reverse operation:

- When input signal *increases*, the display *decreases*.
- When input signal *decreases*, the display *increases*.

3. Scaling the indicator.

After deciding the values for INPUT and DISPLAY and the decimal point position, we are ready to enter in the display configuration module. It has six configurable menus: **scaling**, **balanced filter**, **damping filter**, **round filter**, **tare and sensor break detection**.

[17.1] Display configuration

From the run mode, press **ENTER** to get access to the programming mode (the display shows -Pro-). Press two times the **▶** key to go to the entry stage of the display configuration module. To access the display configuration menus press **ENTER** key

- ▶** Continues to the next display configuration menu
- ENTER** Enters in the selected menu.
- ESC** Brings the instrument to the run mode.

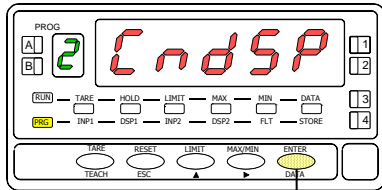

ENTER

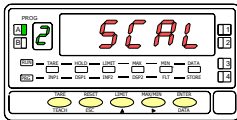

**MENU 2A
SCALING**

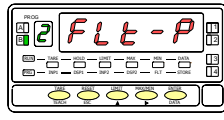

**MENU 2B
BALANCED
FILTER**

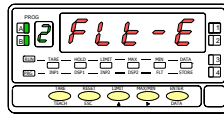

**MENU 2AB
DAMPING FILTER**

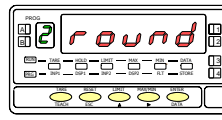

**MENU 2
ROUND
FILTER**

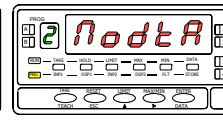

**MENU 2
MODE
TARE**

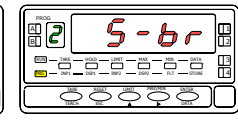

**MENU 2
SENSOR
BREAK**

MENU 2A - SCALE

This menu allows programming the necessary parameters to determine the display range (INP1 - DSP1 - Decimal Point - INP2 - DSP2 - INP3 - DSP3 ...). As a default, these values are expected to be introduced by keyboard. To use the actual signal input values as INP# parameters, it is sufficient to push on the **TEACH** key at INPUT programming phases.

VERY IMPORTANT: Scaling the meter with a tare value different from zero may cause false readings. Before trying to program the scale, check the TARE LED and, if activated proceed to clear the tare memory (Fig. 25.2).

[18.1] Scaling configuration

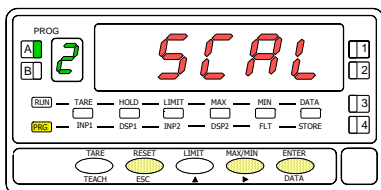

The figure 18.1 shows the indication (**SCAL**) corresponding to entry stage into the scaling menu. Press **ENTER** to accede this menu.

- ENTER** To accede the scale configuration.
- ▶** To skip over this stage and go to the next programming menu.
- ESC** To exit from the programming mode without saving changes.

[18.2] Input 1 value

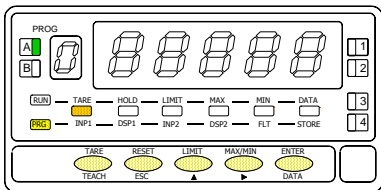

Programming input value at point 1, led INP1 on.

Key-in method: Select the blinking sign in the auxiliar display with **▲** key ["0" = positive, "-" = negative]. Press **▶** key to go to the main display. Enter the value digit by digit from left to right. Press repeatedly **▲** key to change the value of the blinking digit and press **▶** key to move to the right digit up to complete the value.

Teach method: Press **TEACH** key to display the real input value.

- ENTER** Validates the data and proceed to the next programming step.
- ESC** To exit from the programming mode without saving changes.

[18.3] Display 1 value

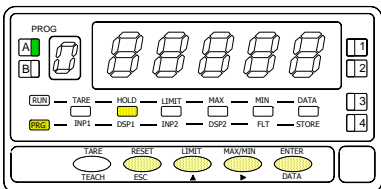

Programming of the display value for the first point, LED DSP1. Enter the value digit by digit from left to right. Press **▲** key to modify the blinking digit and press **▶** key to move to the right digit up to complete the value and the sign. If the programmed value exceeds from these limits, the meter indicates Error, then displays 32000 with the first digit in flash to allow reprogramming the value within limits. **ENTER** To save the entry into the memory and go to the next programming menu.

- ESC** To exit from the programming mode without saving changes.

[19.1] Decimal point

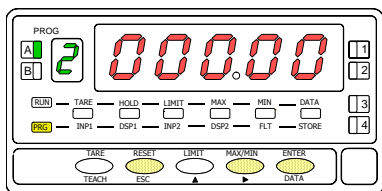

Programming the decimal point which appears blinking.
Press repeatedly the key to move it to the right until desired position. Si If no decimal point is required, it must be placed to the right side of the display. The decimal point remains in the selected position in all programming phases and the run mode.

- To save the entry into the memory and go to the next programming menu.
- To exit from the programming mode without saving changes.

[19.2] Input 2 value

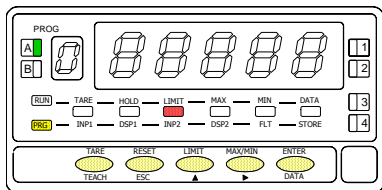

The previously programmed INP2 value appears on the display, LED INP2 activated.
Key-in method: Select the blinking sign in the auxiliar display with key ["0" = positive, "-" = negative]. Press key to go to the main display. Enter the value digit by digit from left to right. Press repeatedly key to change the value of the blinking digit and press key to move to the right digit up to complete the value.

Teach method: Press to view the actual signal value present at the input connector.

- Validates the data and proceed to the next programming step.
- To exit from the programming mode without saving changes.

[19.3] Display 2 value

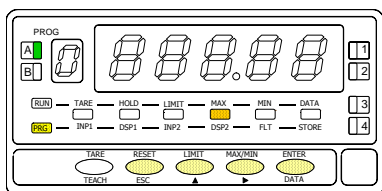

Programming of the display value for the first point, activated LED DSP2. Enter the value digit by digit from left to right. Press key to change the value of the blinking digit and press key to go to the next digit to complete the desired value and sign. If the programmed value exceeds from these limits, the meter indicates Error, then displays 32000 with the first digit in flash to allow reprogramming the DSP2 value within limits. Enter the value:

- c) To save the entry into the memory and return to run mode, press ;
- d) To access to the scale linelization points, press 3 seconds.

- To exit from the programming mode without saving changes

VERY IMPORTANT: Scaling the meter with a tare value different from zero may cause false readings. Before trying to program the scale, check the TARE LED and, if activated proceed to clear the tare memory

[20.1] Point 3

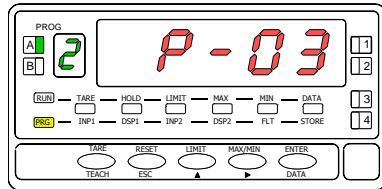

[20.2] Input 3 value

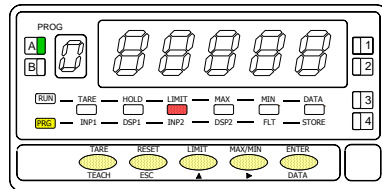

[20.3] Display 3 value

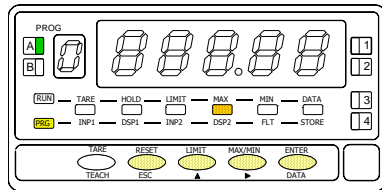

1 second flag indication for scaling point 3

Multi-slope scaling sequence begins at this step.

Programming the input value at point 3, led INP2 on.

Key-in method: Use to switch between "0" (positive) and "-" (negative). Press to go to the main display. Enter the value digit by digit and from left to right. Press to modify the blinking digit and press key to move to the right digit to complete the value.

Teach method: Press to view the actual signal value present at the input connector

Press to accept this value as INP3 and go next step.

To exit from the programming mode without saving changes.

Programming of the display value for the third point, activated LED DSP2. Enter the value digit by digit from left to right. Press key to modify the blinking digit and press key to move to the right digit up to complete the value and the sign. If the programmed value exceeds from these limits, the meter indicates Error, then displays 32000 with the first digit in flash to allow reprogramming the DSP3 value within limits.

c) To validate data and advance to the next point ; press ; or

d) To save the programmed data in the memory and return to the run mode (the meter is scaled by three points), press and hold down for 3 seconds.

To exit from the programming mode without saving changes.

[21.1] Point 4

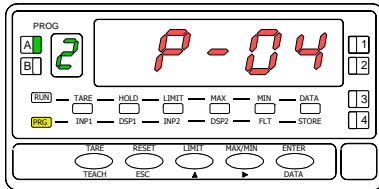

1 second flag indication for scaling point 4.

NOTE: The instructions given for programming point 4 are applicable to the programming of points 5 to 30.

[21.2] Input 4 value

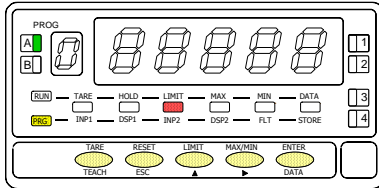

The previously programmed INP4 value appears on the display, LED INP2 activated.

Key-in method: Select the blinking sign in the auxiliary display with **▲** key ["0" = positive, "-" = negative]. Press **▶** to move to the main display. Enter the value digit by digit and from left to right. Press **▲** key to modify the blinking digit and press **▶** key to move to the right digit up to complete the value.

Teach method: Press **TEACH** to view the actual signal value present at the input connector

ENTER Press **ENTER** to accept this value as INP4 and go next step

ESC To exit from the programming mode without saving changes.

[21.3] Display 4 value

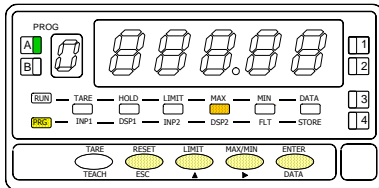

Programming of the display value for the fourth point activated LED DSP2. Enter the value digit by digit and left to right. Press **▲** key to modify the blinking digit and press **▶** key to move to the right digit up to complete the value and the sign. The maximum value is +32000 points and the minimum value -32000 points. A upper or lower value will display error, leaving the 32000 value and corresponding sign Once entered the correct value:

c) To validate data and advance to the next point ; press **ENTER** ; or

d) To save the programmed data in the memory and return to the run mode (the meter is scaled by four points), press and hold down **ENTER** for 3 seconds.

ESC Return to previous point

[22.2] Point 30

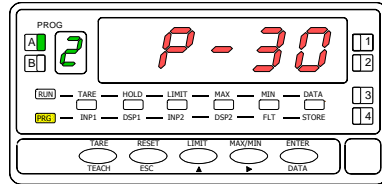

1 second flag indication for scaling point 30.

[22.2] Input 30 value

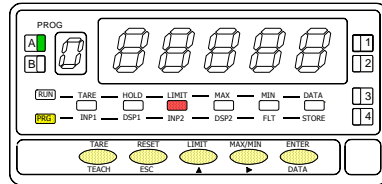

The previously programmed INP30 value appears on the display, LED INP2 activated. **Key-in method:** Select the blinking sign in the auxiliary display with **▲** key ["0" = positive, "-" = negative]. Press **▶** to move to the main display. Enter the value digit by digit and from left to right. Press **▲** key to modify the blinking digit and press **▶** key to move to the right digit up to complete the value.

Teach method: Press **TEACH** to view the actual signal value present at the input connector.

ENTER Press **ENTER** to accept this value as INP30 and go next step.
ESC To exit from the programming mode without saving changes.

[22.3] Display 30 value

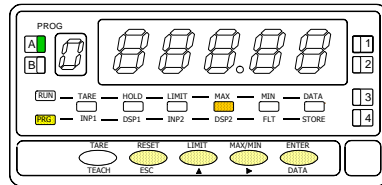

Program the display value for the point 30, LED DSP30 activated. Enter the value digit by digit and left to right. Press **▲** key to modify the blinking digit and press **▶** key to move to the right digit up to complete the value and the sign. The limits of the span are -32000 and 32000 points. If the programmed value exceeds from these limits, the meter indicates Error, then displays 32000 with the first digit in flash to allow reprogramming the DSP12 value within limits.

ENTER To save the entry into the memory and return to run mode.
ESC Return to previous point

MENU 2B - BALANCED FILTER

The balanced filter acts as a delay on the display response to signal variations produced at the input. The filtering level is programmable from 0 to 9. The effect of incrementing this filter level results in a softer response of the display to the input variations. Level 0 disables the filter.

[23.1] Balanced filter

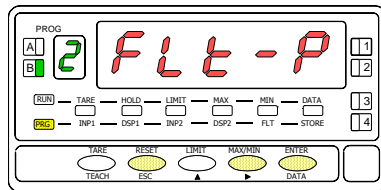

The figure 23.1 shows the indication (FLT-P) corresponding to entry stage of the balanced filter menu. Press the **ENTER** key to accede this menu.

- ENTER** To accede to the programming filter.
- ▶** To skip over this menu and go to next one.
- ESC** To exit from the programming mode without saving changes

[23.2] Filter value

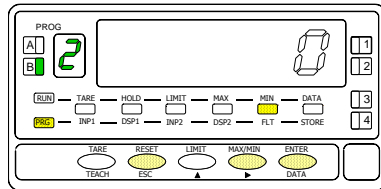

The figure 22.2 shows the initially selected level for the filter-P (any number between 0 and 9) with the FLT LED activated.

Press repeatedly the **▶** key to change the digit until desired value appears on the display.

- ENTER** To save the entry into the memory and go to the next programming menu.
- ESC** To exit from the programming mode without saving changes.

MENU 2AB - DAMPING FILTER

The damping filter cuts off input values exceeding from the limits of a symmetrical band. This band becomes more selective as the filter level is increased. The filtering level is programmable from 0 to 9. Level 0 disables the filter.

[24.1] Damping filter

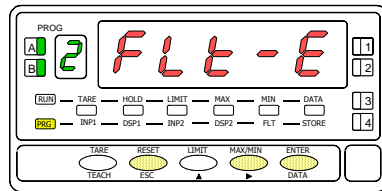

The figure 24.1 shows the indication (**FLt-E**) corresponding to entry stage of the damping filter menu. Press the **ENTER** key to accede this menu.

- ENTER** To access to program the filter level.
- ▶** To skip over this menu and go to next one.
- ESC** To exit from the programming mode without saving changes

[24.2] Filter value

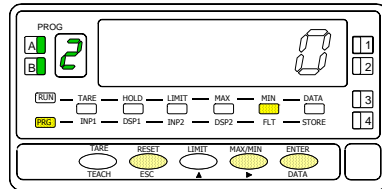

The figure 23.2 shows the initially selected level for the filter-E (any number between 0 and 9) with the FLT LED activated.

Press repeatedly the **▶** key to change the digit until desired value appears on the display.

- ENTER** To save the entry into the memory and go to the next programming menu.
- ESC** To exit from the programming mode without saving changes.

MENU 2AB - ROUND FILTER

This menu allows selection among 4 levels of display rounding. When resolution is not critical, a rounding increment higher than 1, may help to stabilize the display.

[25.1] Round filter

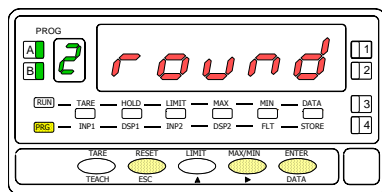

The figure 25.1 shows the indication (**round**) corresponding to the round menu. Press **ENTER** to access the configurations

- ENTER** To get access to the round level selection.
- ▶** To Skip over this menu and pass to the next one.
- ESC** To exit from the programming mode without saving changes.

[25.2] Rounding increment

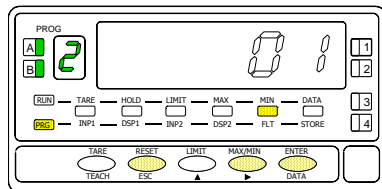

Program the rounding increment, LED FLT activated.

The display shows the previously selected round level. To change this parameter, press repeatedly the **▶** key to rotate around the different options: [01 = no rounding, 02 = round to 2 counts, 05 = round to 5 counts, 10 = round to 10 counts].

- ENTER** To save the option present on display and return to the run mode.
- ESC** To exit from the programming mode without saving changes.

MENU 2 – MODE TARE

In this menu you can configure the mode TARE

[26.1] Mode TARE

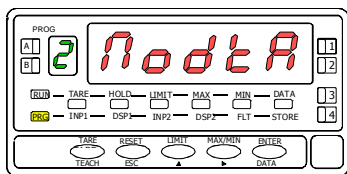

The figure 26.1 displays the text (**ModtA**) that corresponds to the menu that allows the selection of the mode TARE.

Press **ENTER** key to access this menu.

- ENTER** Access the configuration.
- ▶** Goes to the next menu.
- ESC** Cancels programming and return to the run mode.

[26.2] Mode TARE selection

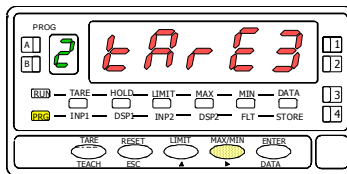

Programming of the tare mode.

Select the mode tare by pressing the **▶** key [**tArE1**, **tArE2**, **tArE3**]. (See description in the next pages)



- ENTER** Store the value in memory and return to the run mode.
- ESC** Cancel programming and return to the run mode.

With the  key we select the tare processing mode of the instrument. When you access this menu, the stored tare value is reset to zero and as always that the instrument is in this state, the Tare LED will be turned off. Once selected the run mode, we exit to the run mode where the tare process will be done.



tArE1

On **tArE1** mode at one press of the  key, the instrument stores the value shown on display at this moment, if it is not on overflow, the TARE LED lights and from this moment the shown value is **net** value (the measured minus the stored). If the instrument already has a TARE and you press once again the TARE key the value shown at this moment will be added to the previous TARE value, being the sum of both the resulting TARE. To clear TARE value, see page 30

tArE2

In this mode, the **TARE** key has no effect if the instrument is in run mode. The tare value now is entered manually, being the instrument run like in the previous mode. To the edit menu we will access from the run mode, by pressing the **ENTER** key going to the **-Pro-** mode and by pressing **TARE** key more than 3 seconds we can enter the tare value to memory using the  and  keys and pressing **ENTER** key we return to the run mode with the TARE LED turned on, not allowing do more tares from the keyboard. It has to be reprogrammed to reset the tare.

tArE3

In this mode we have to program the "net" value, from RUN mode press more than 3 seconds the  key and according the diagram, program the net value (usually indicated in the container). Action TARE, as in the tArE2 case will not take effect until a press of  key, being the instrument in RUN mode, also the TARE LED will light. The value stored now on TARE is the difference between the measured value at the moment of TARE was made and the "net" value programmed. Being the display shown, the difference between the measured and calculated tare. You will need to enter the programming menu and go through "CndSP" > "ModtA" to delete the TARE, the  key is inactive until reprogrammed.

Example:

A process using the liquid in a container that is known as the manufacture's gross weight 100Kg and 75Kg net. It is used in the process of weighing a load cell connected to an instrument and need to know the net weight of liquid at every moment of the process. Selecting this mode of tare, net value would be introduced by editing. When the instrument is measuring the weight of the drum, now completely filled with liquid, which would be 100Kg, tare the instrument and the measure now shows 75Kg and measuring from this value to 0 during the emptying of it

2.5 – PROGRAMMING NET VALUE IN TARE MODE 3

To edit the net value, being the instrument in RUN mode, press the **ENTER** key to get the indication –Pro- then press the **TARE** key more than 3 seconds, showing the display the last TARE value programmed and the most left red digit blinking with **▶** key and **▲** key program the NET value, usually indicated on the container, validate with **ENTER** key and the instrument goes back to normal working, **at this moment with the container over the platform should be pressed ENTER key** , passing the instrument to show the programmed net weight and activating the TARE led, from this moment on the TARE key has no effect on the weight indication.

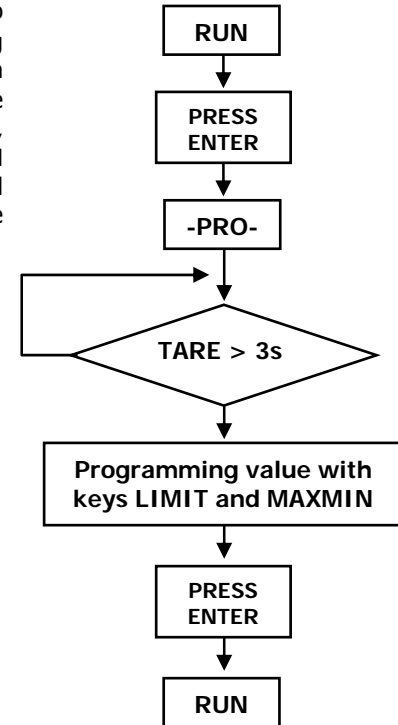

MENU 2 – SENSOR BREAK

This function allows detecting any broken wire that connects the sensor “Load Cell” to the instrument. The analysis to detect the broken wires is done every 1.5 seconds and the response of Relays and ANA options (if used) will be the same if it were a overflow (oVFLo) situation, input signal greater than allowed.

NOTE: This detection system only works if the sensor is supplied with the excitation voltage from the instrument.

[29.1] Sensor break

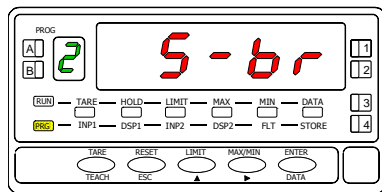

The figure [29.1] shows the indication (S-br) corresponding to the menu that allows activating or deactivating the sensor break detection.

- Access to the configuration “sensor break”
- Pass to the next menu
- Cancel programming and return to run mode.

[29.2]

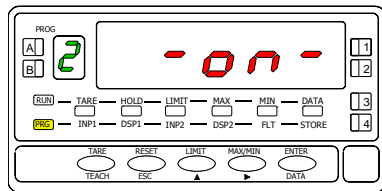

Programming activation or deactivation sensor break detection figure [29.2]

- Selects **-on-** (activate detection), **-off-** (deactivate detection)
- Stores the value into memory and goes back to run mode.
- Cancel programming and return to run mode.

[29.3]

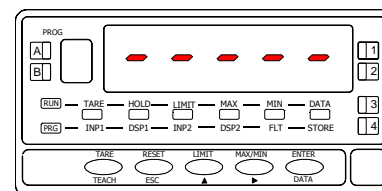

When detects the Sensor break, the indication “----” will be shown on display. If though the serial option (RS2 or RS4) are asking for the display value instead a numerical value will be send 5 caracters ASCII “2D” in hexadecimal corresponding to sign ‘-’.

3. KEYBOARD AND REMOTE CONTROLS

3.1 - KEYBOARD FUNCTIONS

The front-panel keyboard includes the following function keys: **TARE**, **RESET**, **LIMIT** and **MAX/MIN**. The functionality of each one, which is available in the "RUN" mode, is described next.

TARE. A push of this key adds the current display value to the tare memory and brings the display to zero. The "TARE" LED indicates that a tare value different from zero is contained in the tare memory.

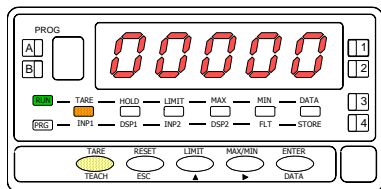

[30.1] Tare operation

RESET TARE. Press and hold down the "RESET" key, then press the "TARE" key. Release first "TARE" then "RESET". To take a tare or reset it back to zero, be sure these functions are enabled by software (see Fig. 22.2, TARE menu, UnLoCK option).

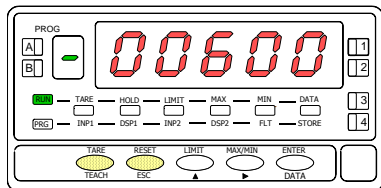

[30.2] Tare reset

LIMIT. During the RUN mode, this key is only operative in case that the instrument incorporates one of the following output options: 2 relays (ref. **2RE**), 4 relays (ref. **4RE**), 4 NPN transistors (ref. **4OP**) or 4 PNP transistors (ref. **4OPP**). At one push of "LIMIT" key the display illuminates the "limit" LED and reads the first programmed setpoint value with the LED 1 activated. New strokes on the LIMIT key recall successively the rest of the setpoints with the corresponding LED (on the right) activated.

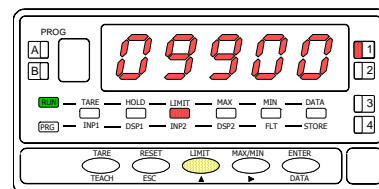

[30.3] Setpoint 1 value

The setpoint values are shown at each push of the "LIMIT" key independently of whether they are enabled or inhibited. 15 seconds after the last key operation or by a push of "LIMIT" from the visualisation of the last setpoint, the auxiliary display blanks and the meter returns to the normal reading.

MAX/MIN. This key calls up the peak and valley values contained in memory. The first push recalls the maximum value reached for the variable since the last reset operation (peak) and activates the "MAX" LED.

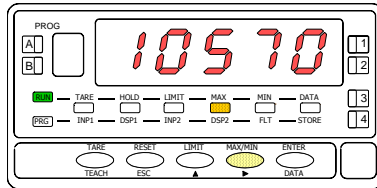

[31.1] Peak

The second push recalls the minimum value registered after the last reset (valley) and activates the "MIN" LED.

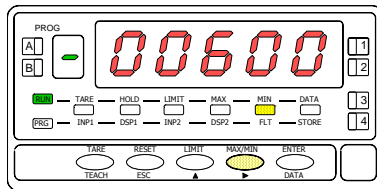

[31.2] Valley

A third push brings the meter to the normal reading. The peak and valley values are updated even when they are registered on the display.

To erase the peak and/or valley memories, press "MAX/MIN" one or two times to display the value to be reset. Press and hold down the "RESET" key and simultaneously press "MAX/MIN". Release "MAX/MIN" then "RESET".

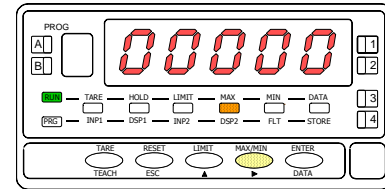

[31.3] Reset of the peak memory

RESET. The "RESET" key is used in conjunction with "TARE" and "MAX/MIN" to erase the memories of tare and peak/valley respectively.

When a tare or a tare reset operation is performed, the peak and valley are updated with the new display value.

BACK TO FACTORY CONFIGURATION

See page 43.

3.2 - REMOTE FUNCTIONS (CN2)

The rear connector CN2 provides 4 user programmable optocoupled inputs that can be operated from external contacts or logic levels supplied by an electronic system. Four different functions may be then added to the functions available from the front-panel keys. Each function is associated to one of the CN2 connector pins (PIN 1, PIN 2, PIN 4 and PIN 5) and is activated by applying a falling edge or a low level pulse to the corresponding pin with respect to common (PIN 3). Each pin can be assigned one of the 36 functions listed on the following pages.

Factory default

As shipped from the factory, the CN2 connector allows the TARE, MAX/MIN and RESET operations be made in the same way as from the front-panel keyboard and incorporates one more function: the display HOLD.

The HOLD state, which is acknowledged by the LED "HOLD", freezes the display, the BCD and the analog outputs but does not halt the meter's internal operation nor the alarm outputs. The HOLD state is maintained as long as pin2 is kept to a low level with respect to pin 3.

CN2 : Default configuration

PIN (INPUT)	Function	Number
PIN 1 (INP-1)	RESET	Function n° 7
PIN 2 (INP-2)	HOLD	Function n° 9
PIN 3	COMMON	
PIN 4 (INP-4)	TARE	Function n° 1
PIN 5 (INP-5)	PEAK/VALLEY	Function n° 6

The external electronics applied to the CN2 connector must be capable of withstanding 40 V and 20 mA present at all terminals with respect to COMMON. In order to guarantee the electromagnetic compatibility, please refer to the instructions given on page 10.

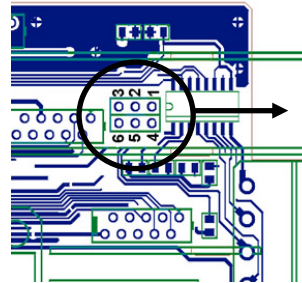

Fig. 32.1

Logic Change CN2
CN2 Input

PNP J1 (2-3) & J2 (5-6)
NPN J1 (1-2) & J2 (4-5)

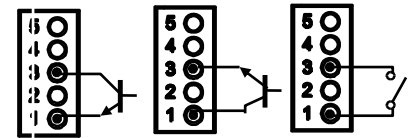
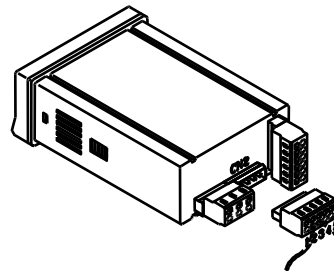
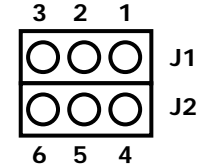

Fig. 32.2 Examples of connection. PNP, NPN or contact closure

3.3 - TABLE OF PROGRAMMABLE FUNCTIONS

- Nº: Function number.
- Function: Function name
- Description: Description and characteristics of the function.
- Activation:
 - Falling edge: The operation is performed on a falling edge applied to the pin with respect to COMMON.
 - Low level: The function remains activated while the corresponding pin is held at a low level with respect to COMMON. (*)

Default factory configuration. It can be restored by programming all pins to '0'

0 to 9: DISPLAY / MEMORY FUNCTIONS

Nº	Function	Description	Activation
0	None	Deactivated. The pin has no function	None
1	TARE (*)	Adds the current display value to the tare memory. The display goes to zero	Falling edge
2	RESET TARE	Adds the tare memory contents to the display value and clears the tare memory	Falling edge
3	PEAK	Recalls peak value. A new falling edge returns to normal reading	Falling edge
4	VALLEY	Recalls valley value. A new falling edge returns to normal reading	Falling edge
5	RESET PEAK/VALLEY	Clears the peak or valley memory (if the values are on display)	Falling edge
6	PEAK/VALLEY (*)	1 st push recalls peak, 2 nd push recalls valley, 3 rd push brings the meter to the indication of the variable being measured	Falling edge
7	RESET (*)	Combined with (1) clears the tare memory Combined with (6) clears the peak or valley memories	Falling edge combined with (1) or (6)
8	HOLD1	Holds the display while the outputs remain active	Low level
9	HOLD2 (*)	Holds the display, the BCD and the analogical outputs	Low level

10 to 12: FUNCTIONS ASSOCIATED WITH THE DISPLAY OF THE INPUT VARIABLE

Nº	Function	Description	Activation
10	INPUT	Displays the actual input signal value in mV (flashing)	Low level
11	GROSS	Displays the measured value + the tare value = gross	Low level
12	TARE	Displays the amount of tare contained in the memory	Low level

13 to 16: FUNCTIONS ASSOCIATED WITH THE ANALOG OUTPUT

N°	Function	Description	Activation
13	ANA GROSS	Makes the analog output follow the gross value (measured value + tare).	Low level
14	ZERO ANA	Puts the analog output to the zero state (0 V for 0-10 V, 4 mA for 4-20 mA)	Low level
15	ANA PEAK	Makes the analog output follow the peak value	Low level
16	ANA VALLEY	Makes the analog output follow the valley value	Low level

17 to 23: FUNCTIONS FOR USE WITH A PRINTER VIA THE RS OUTPUTS

N°	Function	Description	Activation
17	PRINT NET	Prints the net value.	Falling edge
18	PRINT GROSS	Prints the gross value.	Falling edge
19	PRINT TARE	Prints the tare value.	Falling edge
20	PRINT SET1	Prints the setpoint1 value and its output status.	Falling edge
21	PRINT SET2	Prints the setpoint2 value and its output status.	Falling edge
22	PRINT SET3	Prints the setpoint3 value and its output status.	Falling edge
23	PRINT SET4	Prints the setpoint4 value and its output status.	Falling edge

24 to 25: FUNCTIONS ASSOCIATED WITH THE SETPOINTS AND RS OUTPUTS

N°	Function	Description	Activation
24	FALSE SETPOINTS	Exclusively for instruments WITHOUT relays/transistors control outputs card. Allows programming and operation of 4 setpoints.	Low level
25	RESET SETPOINTS	Exclusively for instruments with 1 or more setpoints programmed as "latched setpoints". Deactivates the setpoints output.	Falling edge

26 to 28 : SPECIAL FUNCTIONS

N°	Function	Description	Activation
26	ROUND RS	The display value as sent via the RS output, includes no filtering or rounding	Low level
27	ROUND BCD	Makes the BCD output follow the display value without rounding.	Low level
28	SEND ASCII	Transmission of the last four digits of the display to a remote serial indicator model MICRA-S. By holding the pin to a low level, the display is continuously sent at a rate of 1 message per second.	Low level or Falling edge

29 to 36 : NEW FUNCTIONS

N°	Function	Description	Activation
29	Deactivate Setpoints	Deactivates the activity of the setpoints and leaves the outputs at still	Low level
30	Batch	Adds the present value of the display to the totalizer and increments the batch counter once.	Impulse
31	Visualize Total	The value of the totalizer appears in the display, alternating its high part and low part of four digits each. The auxiliary display shows "H" or "L", depending of which part we are looking to.	Low level
32	Visualize Batch	The display shows the value of the batch counter. The auxiliary display indicates "b".	Low level
33	Reset Total y Batch	Reset the totalizer and batch counter	Impulse
35	Imprimir Total y Batch	Print Total and Batch	Impulse
36	Hold and print the Max.	When activated it resets the value of the Max. Then it saves the maximal value while the function is still activated. Finally it prints it when the function is deactivated	Low level

3.4 - PROGRAMMING THE LOGIC INPUTS

After deciding the functions for each connector pin, we are ready to enter in the logic inputs configuration module (6 LoGIn) to effectively programming the logic inputs.

[36.1] Logic inputs

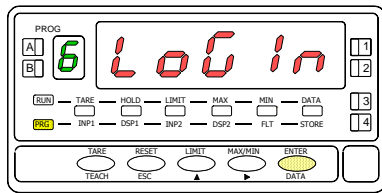

From the run mode, press **ENTER** to get access to the programming mode (the display shows -Pro-). Press six times the **▶** key to go to the entry stage of the logic inputs configuration module, represented in fig. 36.1. This module provides four menus for programming the input pins. Press **ENTER** to accede to the first menu (InP1) and press repeatedly the **▶** key to rotate around the different menus.

- ▶** skips over this module and advances to the next one or to the -Pro- stage.
- ENTER** Exits from the programming routines and brings the instrument to the run mode.

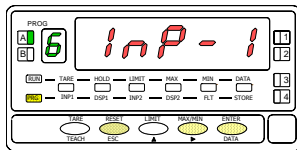

**MENU 6A
PROGRAMMING
PIN1**

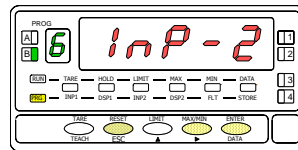

**MENU 6B
PROGRAMMING
PIN2**

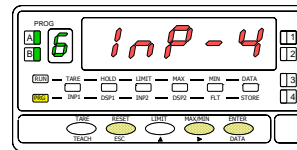

**MENU 6AB
PROGRAMMING
PIN4**

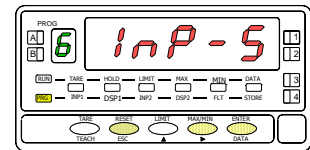

**MENU 6
PROGRAMMING
PIN5**

MENU 6A - PIN 1 PROGRAMMING

This menu allows selecting the logic function for PIN 1. Available functions are represented by a number from 0 to 36. Consult tables to find the number corresponding to the desired function. The instructions given below apply to pin function 1. Follow the same procedure to configure the rest of the pins.

[37.1] menu PIN 1

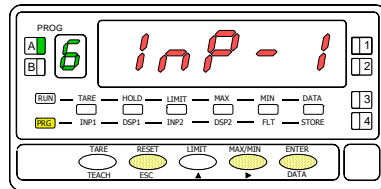

The figure 37.1 shows the indication (**InP-1**) corresponding to the configuration menu for the PIN 1 function. Press the **ENTER** key to accede this configuration.

- ENTER** To access to the programming of the PIN1 function.
- ▶** To skip over this menu and go to PIN 2.
- ESC** To exit from the programming mode without saving changes.

[37.2] Function number

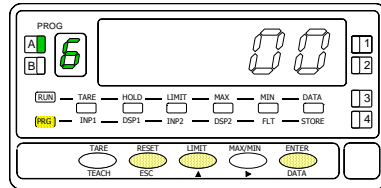

Choose the function number [0-36], according to the table.

- ▲** To change number (hold down to increment automatically).
- ENTER** To save the entry into the memory and return to the run mode.
- ESC** To exit from the programming mode without saving changes.

3.5 – PROGRAMMING LOCK OUT / ACCESS LEVELS

In the RUN mode pulse the **ENTER** key during 3 second to accede to the lock menu (diagram). The instrument has an original lock code which is "0000". By using the **▲** and **▶** keys, it is possible to enter a new lock **Code**. If the introduced code is false, the instrument goes back in RUN mode. When the display shows "LiSt" pulse **▶** to change the code. **Keep your new code in a secure place!**

It is possible to lock totally or partially the instrument's functions. "1" means lock whereas "0" means unlock. After pressing the last **ENTER**, the instrument saves its new configuration. Pulse **ESC** to return to RUN mode without saving the configuration.

- totLL** ... 1=Total lock
0=Lock separately each step
- SEt #** ... Lock prog. Mode Setpoint #.
- INPUt** ... Lock prog. Input.
- SCAL** Lock prog. SCAL.
- FiLT** Lock prog. Filter.
- AnoUt** ... Lock prog. ANA output
- rSoUt** ... Lock prog. RS output
- LoGIn** ... Lock prog. Logical Functions
- SPuAL** ... Lock prog. Direct access to Setpoints
- tArE** Lock keyTARE

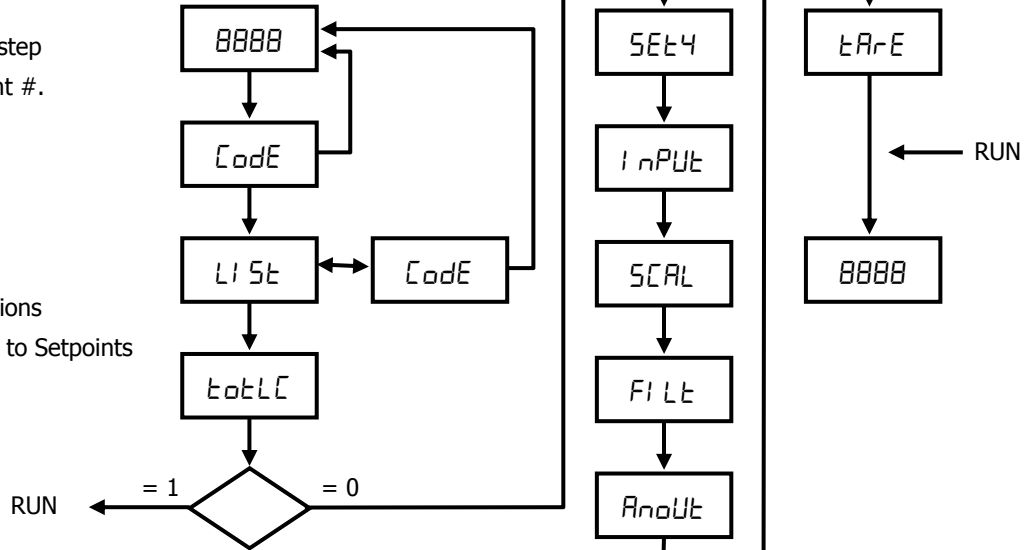

4. OUTPUT OPTIONS

Optionally, the model ALPHA-C can incorporate one or several output options for communications (this output should never be connected to the telephone lines) or control including:

COMMUNICATION

RS2	Serial RS232C
RS4	Serial RS485
BCD	BCD 24V/TTL

CONTROL

ANA	Analogical 4-20 mA, 0-10 V
2RE	2 SPDT relays 8 A
4RE	4 SPST relays 5 A*
4OP	4 open-collector NPN outputs
4OP	4 open-collector PNP outputs

All options are optoisolated with respect to the input signal.

*From n° O5397

The options are supplied with a specific instructions manual describing characteristics, installation, connections and programming. The output cards are easily installed on the meter's main board by means of plug-in connectors and each one activates its own programming module that provides complete software-configuration.

Additional capabilities of the unit with output options:

- Control and processing of limit values via ON/OFF logic outputs (2 relays, 4 relays, 4 NPN outputs or 4 PNP outputs) or proportional output (4-20 mA or 0-10 V).
- Communication, data transmission and remote programming via serial interface.

For more detailed information on characteristics, applications, mounting and programming, please refer to the specific manual supplied with each option.

The figure shows the different locations of the plug-in output cards. Each location corresponds to a specific function: setpoints, analogical and serial outputs.

The options **2RE**, **4RE**, **4OP** and **4OPP** are installed in the M5 connector.

The **ANA** option is installed in the M4 connector.

The options **RS2** and **RS4** are installed in the M1 connector.

Up to three output options can be present at a time and operate simultaneously, but only one from each category:

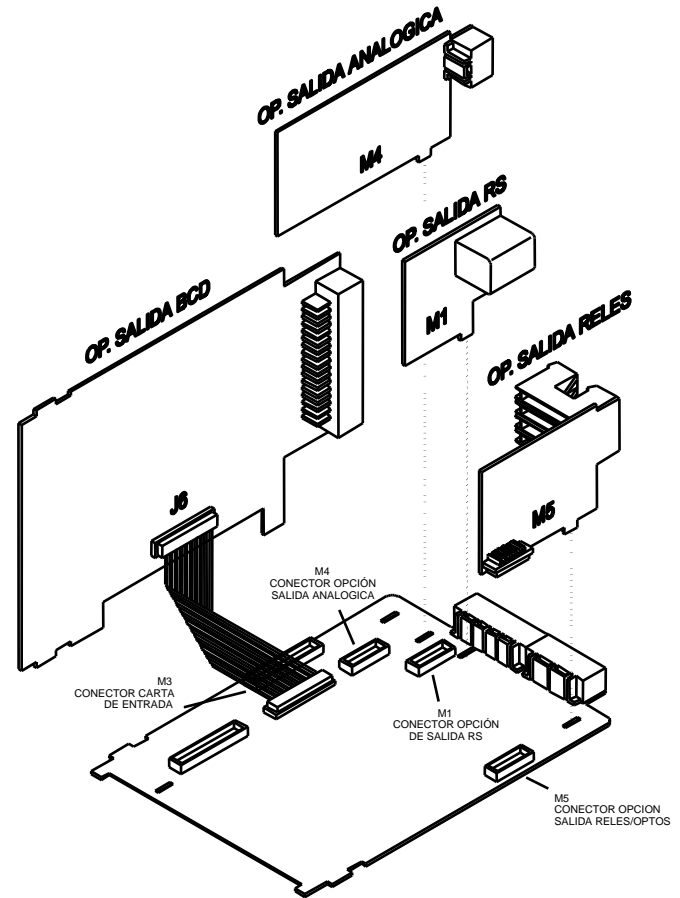

- ANALOGICAL
- RS232C or RS485
- 2 RELAYS, 4 RELAYS, 4 PNP or 4 NPN

The **BCD** output is exclusive and do not allow installation of any other card. This option is connected to the main board by means of a 18-pin FLAT cable.

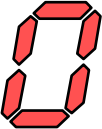
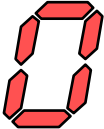
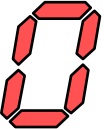
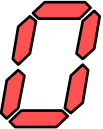

4.1 NEW FUNCTIONS IN SETPOINT OPTION

Available on programming menu 3B-MODE (new function in bold letter)

Digit 1	Digit 2	Digit 3	Digit 4 (*)	Digit 5
				
0= OFF 1= ON 2= ON LATCH 3= RS COM (serial port command)	0= HI NO 1= LO NO 2= HI FAIL SAFE 3= LO FAIL SAFE	0= Delay 1= Hyst -1 2= Hyst -2	0= Neto 1= Track Set 2= Bruto 3= Peak 4= Valley 5= Track Auto 6= Max 7= Max Filtered 9= r.o.C.	0= Alarm LED 1= Alarm LED + Blink Display

(*) The options in the digit 4 depend on the setpoint number. According to the setpoints, are the following:

SET1: 0, 2, 3, 4, 9
 SET2: 0, 1, 2, 3, 4, 5, 6, 7, 9
 SET3: 0, 2, 3, 4, 9
 SET4: 0, 1, 2, 3, 4, 9

FAIL SAFE

Function that allows detecting the power supply fault or an instrument fault and in this way can be informed the PLC or another general system of supervision using the relay option programmed in this way.

r.o.C.

The function **r.o.C (option 9)** is useful to detect the changing speed of display value, depending on programmed setpoint polarity we detect the increasing or decreasing.

In mode **r.o.C.**, if the setpoint values is, for example = 1000, that means that the alarm will be activated when the display value increase more than 1000 points per second.

If the setpoint value were, for example = -1000, the alarm would be activated when the display value decrease with a speed greater than 1000 points per second.

The **r.o.C.** alarms have the same programmable options than the rest of alarms, namely, you can choose the mode of action, HI-LO, NO-NC, Latch, delay-hysteresis, LED-LED+blink. The only difference is if delay is selected, on the **r.o.C.** alarms not apply to the activation and deactivation, but only to the deactivation of the alarm. This function is applicable separately to activate each of setpoints.

Note: The **ovflo** situation (be by sensor break, or excess of input signal, or incorrect programming) leads to the relays to the rest situation that corresponds according to the program established.

FUNCTIONS

RESET CONFIGURATION

To restore the factory configuration, press **ENTER** and **RESET** keys at the same time, during 5 seconds. The lock code will also be put to zero.

SETPOINTS

5. **Setpoints bistable "latch"**. This setpoints once activated, remain in this state, until a external reset of relais is done by logical function 25 (see RESET setpoints, on page 34). Their use will allow us to record the activation of relays, in installations where not to make a visual inspection constantly.
6. **Activation Relay's by:** net value, gross value, peak value or valley value.
7. **Indication of the setpoints activation** by LEDs or by flashing LED and display.
8. **Quick access to the programming of the setpoint values.**

Enable and disable relay / opto (+ LED) by order of RS232C or RS485

This feature is programmed by selecting '3' at the first digit of the mode parameter setpoints (3B ModE).

3	0	0	0	0
---	---	---	---	---

In this case the other options (HI-LO, RET-HYS...) do not act, except the flashing display to activate the relay / opto if selected + LED blink in the last digit of the mode parameter setpoints.

Once activated, these setpoints are not disabled in overflow or to pass programming, only attending to the order via RS2 or RS4.

Use setpoint 2 to detect peak

Enabling this feature by selecting the option '6' or '7' in the fourth digit of the parameter setpoints mode (Mode 3B).

1	0	0	6	0
---	---	---	---	---

The option '6' is for unfiltered peak detection, the option '7' is for filtered peak values. In this case, taking into account all options scheduled for setpoint (Latch, HI-LO, RET-HYS, Blink).

The value to set the parameter value of setpoint (3A SETP) will display the value from which to begin assessing the peak, below this value does not act.

The value set in the value parameter delay / hysteresis (3AB ModE) will remain active while the relay / opto after reaching the peak (except to the latch).

The output relay / opto is activated when the display value continues to increase (once exceeded the value of SETPOINT2) readings for a number of user programmable from 0 to 99.

Programming the number of readings are presented below the setpoint programming mode 2 when you select '6' or '7' in the fourth digit.

RS232

Compatible with ModBus-RTU protocol (see manual ModBus on www.ditel.es).

RS485

Compatible with ModBus-RTU protocol (see manual ModBus on www.ditel.es).

BCD

See logical functions, page 32.

ANALOGICA

See logical functions, page 32.

SERIAL OUTPUT

In the ModBus protocol has been implemented the function 10 (write) and eliminated the 01 and the 0F.

New available commands:

Commands	Function
----------	----------

Request of data	
Z	Transmit totalizar value
B	Transmit batch value

Commands	
z	Resetar valor total
x	Resetar número de lotes
a#	Activar setpoint nº#
d#	Desactivar setpoint nº#

Changing parameters	
S#	Change the value of setpoint # without saving into the memory

Request errors	
E	See Graphics below

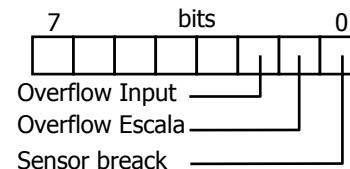

5. TECHNICAL SPECIFICATIONS

INPUT SIGNAL

- Configurationdifferential asymmetrical
- Max Applicable voltage ± 300 mV DC
- Resolution..... 0.5 μ V
- Input impedance 100 M Ω
- Excitation..... 10V (120 mA), 5V (120 mA)

ACCURACY

- Max. error..... \pm (0.1 % of the reading +2 digits)
- Temperature coefficient..... 100 ppm/ $^{\circ}$ C
- Warm-up 10 minutes

FUSES (DIN 41661) (recommended)

- **Alpha-C** (230/115 V AC)..... F 0.2 A/ 250 V
- **Alpha-C1** (10-30 V DC) F 2A/ 250 V
- **Alpha-C2** (24/48 V AC) F 0.5A/ 250 V

A/D CONVERSION

- Technique..... $\Sigma\Delta$
- Resolution..... 24 bits
- Read rate..... 18/ s

FILTERS

Filter P

- Cut -off frequency (- 3 dB)..... from 4Hz to 0.05Hz
- Slope..... from 14 to 37dB/10

Filter E

- Programmable..... 10 levels

DISPLAY

- Main -32000/32000, 5 digits 14 mm red
- Auxiliary..... 1 digit 7.62 mm green
- Decimal point programmable
- LEDs..... 14 (programming and control)
- Display update time..... 62 ms

ERROR INDICATIONS

- Negative over-range -OVFLO
- Positive over-range..... +OVFLO
- Sensor Break..... - - - - -

POWER SUPPLY

- AC voltages. 115/ 230 V, 24/ 48 V ($\pm 10\%$) 50/60 Hz AC
- DC voltages..... 10-30 V DC
- Consumption..... 5 W (without options), 10 W (max)

ENVIRONMENTAL

- Indoor use
- Operating temp -10 $^{\circ}$ C to 60 $^{\circ}$ C
- Storage temp. -25 $^{\circ}$ C to +85 $^{\circ}$ C
- Relative humidity..... <95 % at 40 $^{\circ}$ C
- Altitude max..... 2000 m

MECHANICAL

- Dimensions 96x48x120 mm
- Panel cut-out..... 92x45 mm
- Weight..... 600 g
- Case material policarbonato s/UL 94 V-0
- Front Sealed..... IP65

5.1 - DIMENSIONS AND MOUNTING

To install the instrument into the panel, make a 92x45 mm cut-out and insert the instrument into the panel from the front, placing the sealing gasket between this and the front bezel.

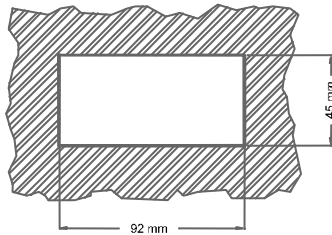

Place the fixing clips on both sides of the case and slide them over the guide tracks until they touch the panel at the rear side.

Press slightly to fasten the bezel to the panel and secure the clips.

To take the instrument out of the panel, pull outwards the rear tabs of the fixing clips to disengage and slide them back over the case.

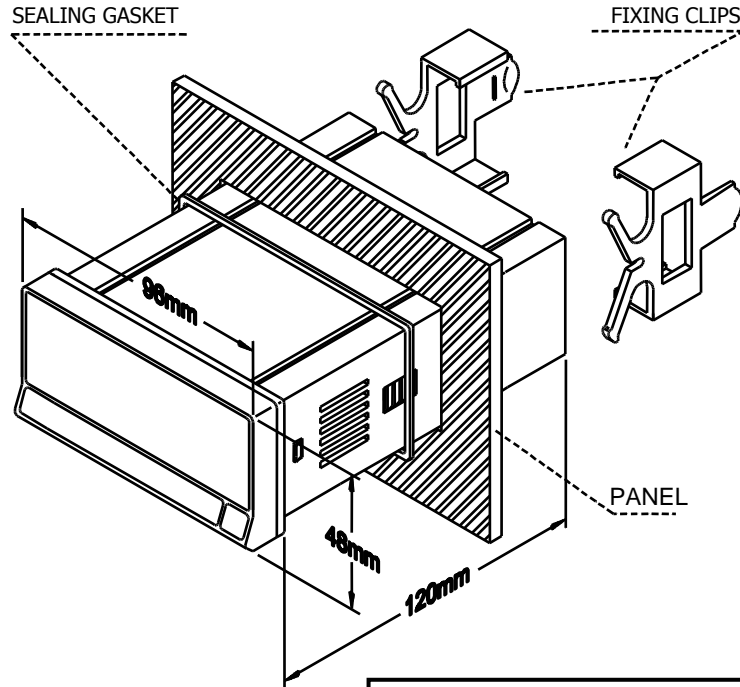

CLEANING: The frontal cover should be cleaned only with a soft cloth soaked in neutral soap product.
DO NOT USE SOLVENTS



The instruments are warranted against defective materials and workmanship for a period of three years from date of delivery.

If a product appears to have a defect or fails during the normal use within the warranty period, please contact the distributor from which you purchased the product.

This warranty does not apply to defects resulting from action of the buyer such as mishandling or improper interfacing.

The liability under this warranty shall extend only to the repair of the instrument. No responsibility is assumed by the manufacturer for any damage which may result from its use.



All the DITEL products benefit from an unlimited and unconditional warranty of THREE (3) years from the date of their purchase. Now you can extend this period of warranty up to FIVE (5) years from the product commissioning, only by fulfilling a form.

Fill out the form in our website:
<http://www.ditel.es/warranty>

7. DECLARATION OF CONFORMITY

Manufacture: DITEL - Diseños y Tecnología S.A.	
Address:	Polígono Industrial Les Guixeres C/ Xarol 8 C 08915 BADALONA-SPAIN
Declares, that the product	
	Name: Digital panel meter
	Model: ALPHA-C
Conforms to:	EMC 2004/108/CEE LVD 2006/95/CEE

Applicable Standards: EN55022/CISPR22	EN50081-1 Generic emission Clase B
Applicable Standards: IEC1000-4-2	EN50082-1 Generic immunity Level 3 Criteria B Air Discharge 8kV Contact Discharge 6kV
IEC1000-4-3	Level 2 Criteria A 3V/m 80...1000MHz
IEC1000-4-4	Level 2 Criteria B 1kV Power Lines 0.5kV Signal Lines
Applicable Standards: IEC1010-1	EN61010-1 Generic Safety Installation Category II Transient Voltages <2.5kV Pollution Degree 2 Conductive pollution excluded Insulation Type Enclosure: Double Inputs/ Outputs: Basic

Date: 30 Juny 2010
Signed: José M. Edo
Charge: Technical Manager



NOTES

NOTES



INSTRUCTIONS FOR THE RECYCLING

This electronic instrument is covered by the **2002/96/CE** European Directive so, it is properly marked with the crossed-out wheeled bin symbol that makes reference to the selective collection for electrical and electronic equipment which indicates that at the end of its lifetime, the final user cannot dispose of it as unsorted municipal waste.

In order to protect the environment and in agreement with the European legislation regarding waste of electrical and electronic equipments from products put on the market after 13 August 2005, the user can give it back, without any cost, to the place where it was acquired to proceed to its controlled treatment and recycling.

DISEÑOS Y TECNOLOGIA, S.A.

Polígono Industrial Les Guixeres

C/ Xarol 8 C

08915 BADALONA-SPAIN

Tel : +34 - 93 339 47 58

Fax : +34 - 93 490 31 45

E-mail : dtl@ditel.es

www.ditel.es