



Quick Start Manual for HI1200 / HI1201 / HI1202



Product Code:

HI1200: Operator Interface with 12.1 inch TFT COLOUR SVGA touch screen, (800 X 600), 256 Colours, RTC, 32 MB Mem, 2 dual serial com ports (CMOS/RS232/RS422/RS485), external 24 VCD power supply

HI1201: Operator Interface with 12.1 inch TFT COLOUR SVGA touch screen, (800 X 600), 256 Colours, RTC, 32 MB Mem, 2 dual serial com ports (CMOS/RS232/RS422/RS485), One Ethernet port and one USB port (for upload/download), external 24 VDC power supply

HI1202: Operator Interface with 12.1 inch TFT COLOUR SVGA touch screen, (800 X 600), 256 Colours, RTC, 32 MB Mem, 2 dual serial com ports (CMOS/RS232/RS422/RS485), One Ethernet port and one USB port (for upload/download), Compact Flash support, external 24 VDC power supply

DITEL (Diseños y Tecnología, S.A.)

P.I. Les Guixeres - C/ Xarol, 8-C
08915 Badalona, SPAIN

www.ditel.es

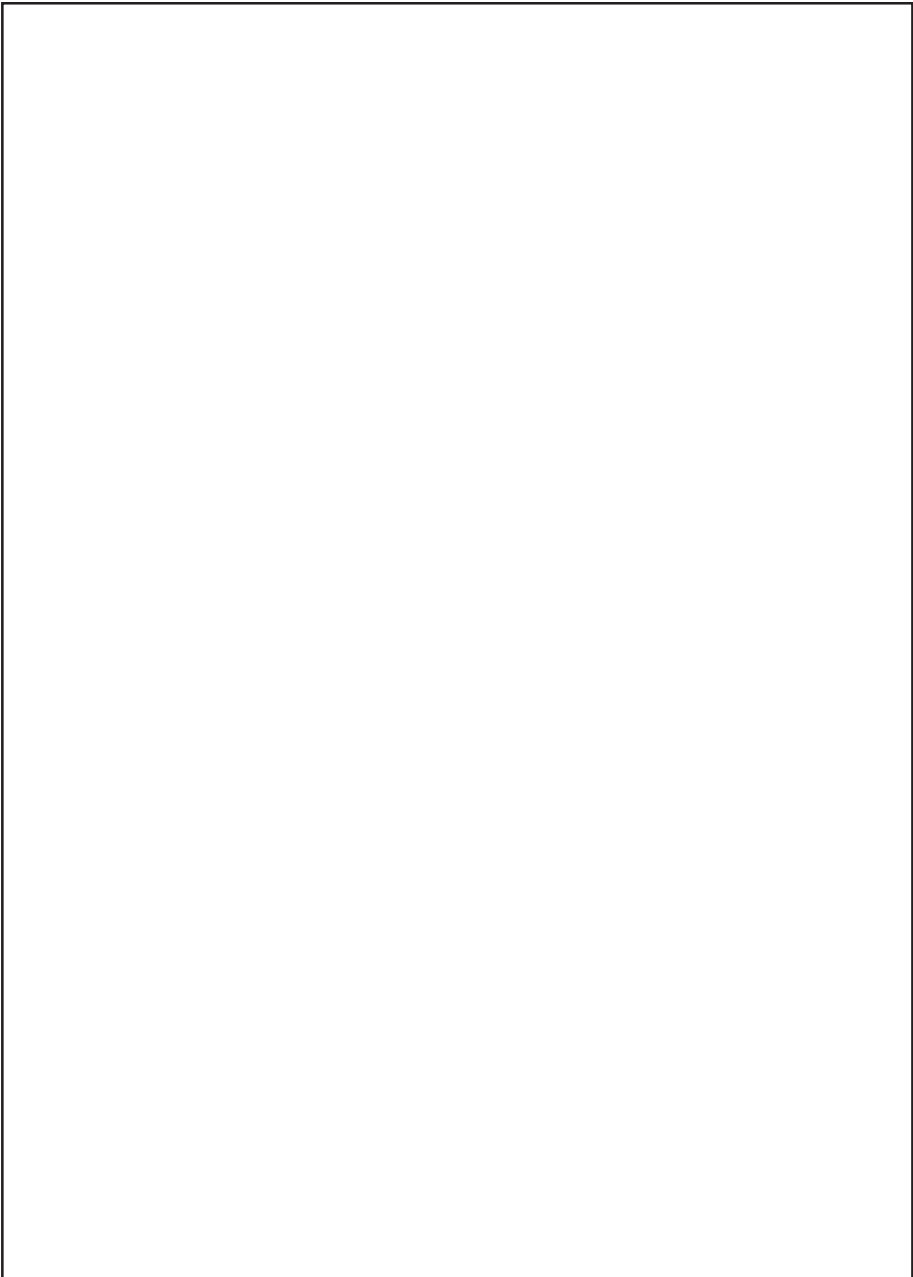

DITEL (Diseños y Tecnología, S.A.)

P.I. Les Guixeres - C/ Xarol, 8-C
08915 Badalona, SPAIN

www.ditel.es

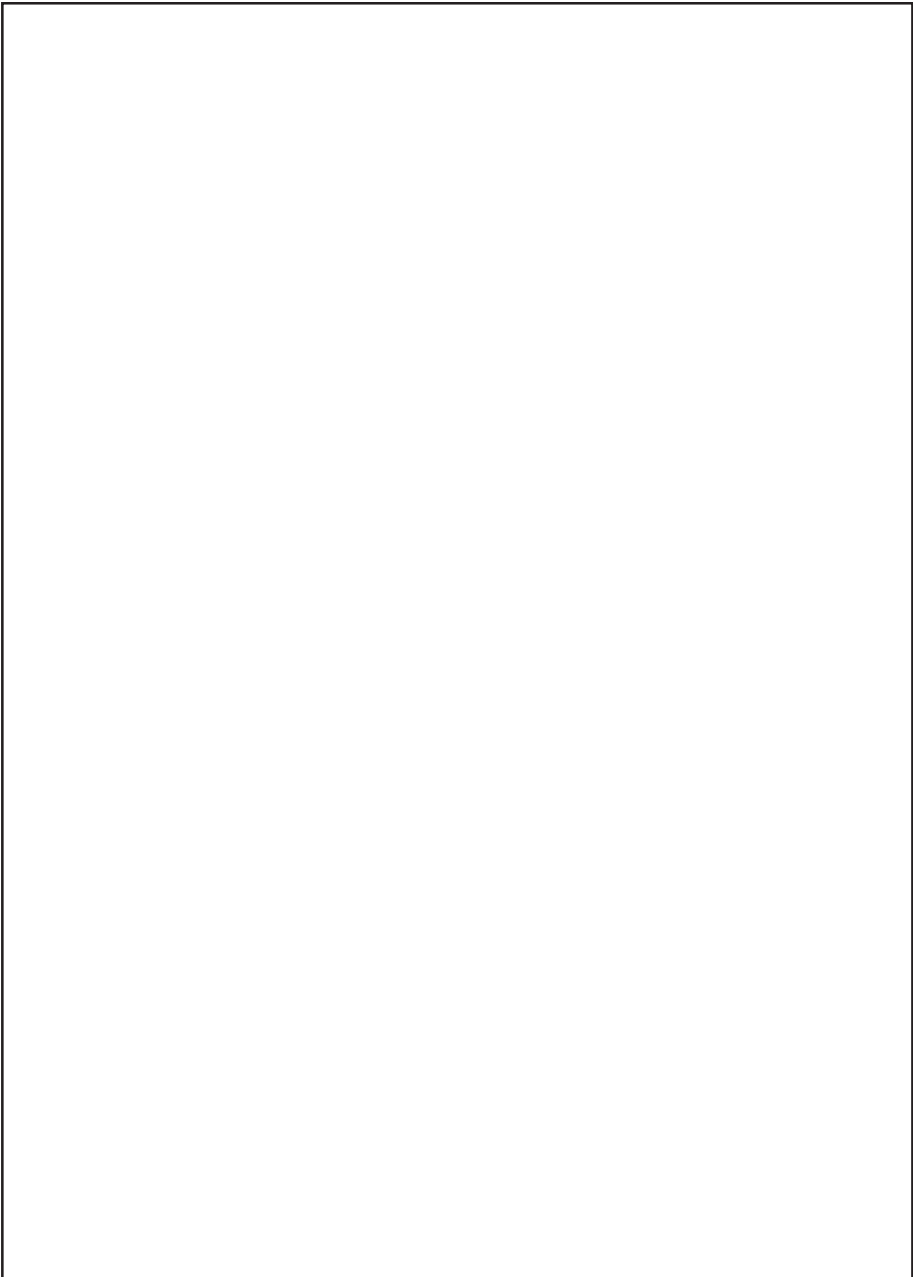

DITEL (Diseños y Tecnología, S.A.)

P.I. Les Guixeres - C/ Xarol, 8-C
08915 Badalona, SPAIN

www.ditel.es

Thank you for purchasing our HIMOS Series product - HI120X. This manual gives you a quick overview of the HIMOS model and it's software. Read this manual thoroughly before installing and operating the unit.

This is only a Quick Start Manual. For detailed information on this product refer to 'HIMOS Operation Manual'. You can download this manual free from the download section of our website. For a printed copy of this manual contact our nearest sales office.

This document is based on information available at the time of it's publication and may not cover all the details or variations in hardware or software. Ditel reserve the right to update information in this publication without prior notice.

IMPORTANT

HIMOS Series Products are intended to be operator interfaces, to work with PLCs which actually take control actions. It is assumed that the user is well acquainted with the PLC system being used and Windows based software usage, in general. Never use HIMOS units to perform emergency stop applications. It is advised that separate switches be used outside the PLC for ANY emergency stops.

Any mechanical or electrical modification to this unit will void all warranties.

◆ **HI1200 / HI1201 / HI1202 Specifications**

HI1200, HI1201 & HI1202 are HIMOS series product. HIMOS Series operator interfaces provide man-machine interface for PLCs / Inverters. It communicates with PLCs / Inverters over serial communication port to fetch the information. Information can be displayed over LCD or can be used to build a logic. HIMOS additionally provide I/O, which can be configured as per customer requirements.

Specifications of HI1200 / HI1201 / HI1202:

Power:	24VDC +/- 10%, 20 W maximum
Display:	12.1" TFT color display with resolution 800 X 600 Pixels, Graphics 256 colors, Backlit LCD
Bezel:	IP65 rated Keypad
LEDs:	4 LEDs
Memory:	32MB Memory
Communication:	Two Universal Serial Ports (RS232/RS485/RS422/CMOS) and One * Ethernet Port
USB Device Port (***):	For Upload and Download
Compact Flash (**):	Yes.
Temperature:	Operating Temp.: 0 to 50 Degree C
Humidity:	10% to 90% (Non condensing)
Immunity to ESD:	Level 3 as per IEC61000-4-2
Immunity to Transients:	Level 3 as per IEC61000-4-4
Radiated Susceptibility:	Level 3 as per IEC61000-4-3
Emissions:	EN55011 CISPR A

System Components:

- HI1200, HI1201, HI1202 units with LCD display with Touch Screen and RTC
- Power Supply connector.
- Installation Kit: Gasket, eight mounting clamps, eight M4 screws, twelve hex nuts.

* Ethernet Port is available in HI1201 & HI1202 models

** Compact Flash support is available in HI1202 model.

*** USB device port support is available in HI1201 & HI1202 models.

Note: User should order PLC / IBM cable separately.

◆ **Port Details:**

Pin description of communication port for HIMOS models is as follows:

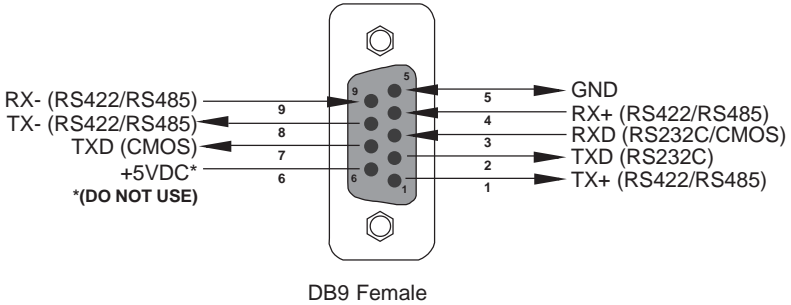

◆ **Panel Mounting and Panel cut-out:**

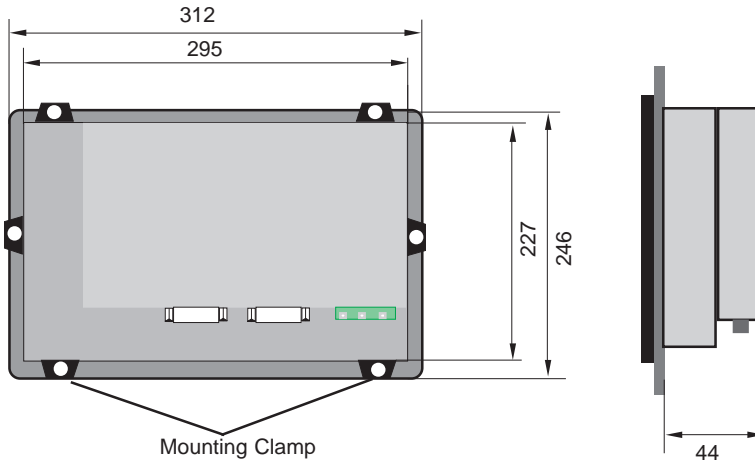

Tighten the mounting screws evenly to a torque between 0.6 and 0.7 Nm to maintain water and dust resistance. Make sure the panel is not dirty and warped and that it is strong enough to hold the unit.

◆ **Safety Precaution**

This equipment is suitable for use in Class 1, Div. 2, Group A, B, C, D or non-hazardous locations only.



WARNING

Explosion Hazard - Substitution of components may impair suitability for Class 1, Div. 2



WARNING

Explosion Hazard - Do not disconnect equipment unless power has been switched OFF or the area is known to be non-hazardous.

◆ **Installation Precaution**



CAUTION

Excess temperature (ambient temperature below 0°C or exceeds 55°C), humidity (below 10% or exceeds 90%), vibration, shocks or dusty and corrosive gas environment can cause electrical shock, fire or malfunction.

Observe the following precautions when installing enclosures in which the unit will be installed:

- Provide the maximum possible distance from high-voltage or high-power panels.
- If installing the enclosures in the vicinity of high-frequency equipment, be sure to correctly ground the enclosures.
- When sharing the channel base with other panels, check for leakage current from the other panels or equipment.

◆ Grounding

The optimum method for grounding electronic equipment is to ground it separately from other high-power systems, and to ground more than one unit of electronic equipment with a single-point ground.

The grounding marked terminal (see below) is provided on the unit.

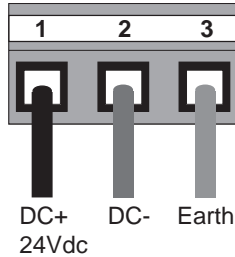

Note: Do not use a ground that has an unstable impedance, such as painted screws, or ground subject to vibration.

◆ **Getting Started**

Follow the sequence to configure and use your HIMOS:

Install HIMOSOFT configuration software.

- Create the application.
- Connect the HIMOS unit to your PC.
- Download the firmware and the application.

Now, your HIMOS unit is ready for use.

◆ **Install the software:**

➤ The minimum system requirements for running the HIMOSOFT are:

Windows Version	:	Microsoft Windows 2000 ^{Note1} or higher
Processor	:	PIII or higher
Hard disk Space	:	175 MB or more
Serial Port	:	Required
RAM	:	64 MB or more
Display resolution	:	800 x 600 (VGA) or better
Display colors	:	16-bit True color or more







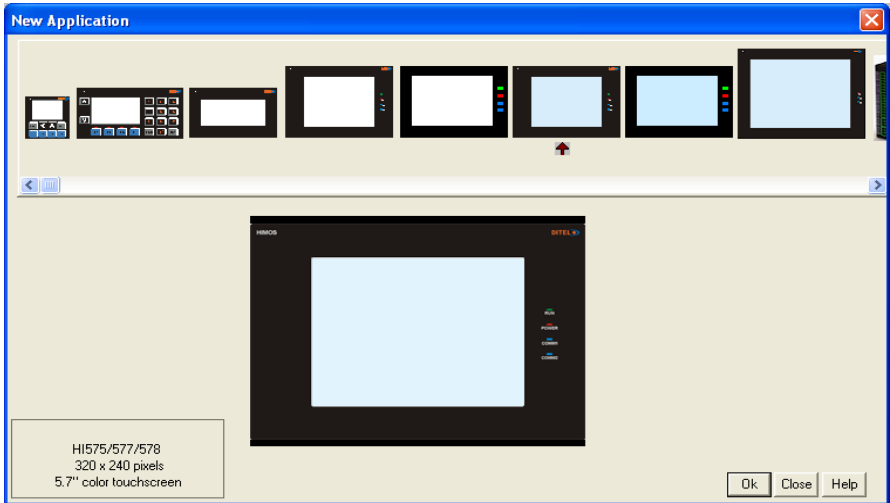

- Insert the CD in the PC drive and follow the instructions given.
- In case the software does not autoexecute, please run the \DISK1\SETUP.EXE file from CD.
- In case software has been downloaded from the Web site, first extract the software installation files, then run the Setup.exe file.

Note1: To execute PLC Logic available in Prizm products, WindowsXP/2000 or higher version is required.

◆ Start-up the HIMOSOFT and define your application



	<p>Unit Settings</p>	<p>Allows the user to define general settings like the number of languages or screen saver function.</p>
	<p>Network Configuration</p>	<p>Configuration of the com ports and selection of the drivers to be used.</p>

	<p>Tags</p>	<p>Coils or registers used in the application must be first defined in the tag database. Actions can then be performed on these tag, like value change, data monitoring, etc.</p>
	<p>Screen</p>	<p>Define the screens and their contents that will be shown on the unit. Screens specific tasks, and keys tasks can be defined for each screen.</p>
	<p>Global Keys</p>	<p>Three types of tasks can be defined for each key: 'Press' Task, 'Pressed' Task, 'Released' Task. Two keys can also be defined to perform Tasks when pressed simultaneously.</p>
	<p>Alarms</p>	<p>Alarms can be defined to monitor any tag. An Alarm is a bit in a particular 2-byte tag. This 2-byte tag acts as a group, and each group can have maximum 16 alarms.</p>
	<p>Application Tasks List</p>	<p>Application Task List is of two types: Power-on Task-List and Global Task-List. Power-On Task-List is performed only once after the unit is powered on. Global Task-List is performed till the unit and PLC are communicating.</p>
	<p>Save</p>	<p>Saves the application to the directory chosen</p>
	<p>Download</p>	<p>Download the application components to the unit.</p>
	<p>Help</p>	<p>On-line help provides detailed explanation on all objects and elements of your application.</p>

◆ How does HIMOS work?

The Microsoft Windows® based configuration software, HIMOSOFT, helps user to configure HIMOS unit. 'Configuration' means making the HIMOS unit work as per the system requirements. For example, HIMOS can be configured to be used with any PLC, display any register data, perform any controlling action depending on digital or analog inputs.

PLC tag Data is displayed on HIMOS Screen. Screen can be defined using HIMOSOFT in the 'WYSIWYG' format

Analog, digital inputs can be displayed on the screen and can be used for some control application. HIMOS Keys can control the process by changing the status of digital as well as analog output as low or high.

Alarms can be defined to constantly monitor any register. When alarm condition is reached, the respective alarm is displayed in alarm window.

LEDs and Screens can be controlled by any tag. Tasks can be defined to perform these operations.

◆ How do I start?

User should follow the given sequence to configure and use any HIMOS series unit:

1. Install HIMOSOFT Configuration Software.
2. Create a HIMOS application using HIMOSOFT software.
3. Connect IBM cable.
4. Download Firmware i.e. driver for the PLC if PLC is being used.
HIMOS cannot communicate with PLC till the required driver is downloaded to the unit.
5. Download application.
6. Now HIMOS is ready for application.

◆ **Cable Diagrams:**

PC to unit Cable:

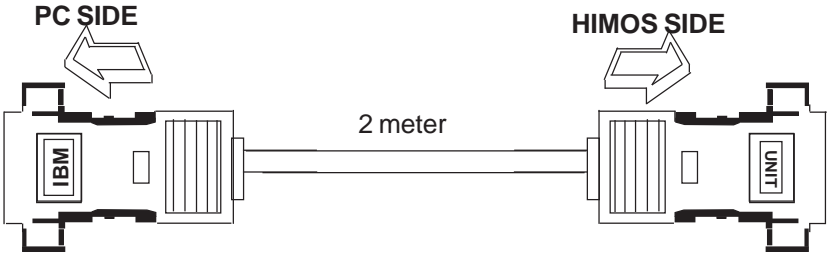

**DB9 FEMALE
(RS232)**

SIGNALS	Pin #
	1
RXD	2
TXD	3
	4
SG	5
	6
	7
	8
	9

**DB9 MALE
(RS232)**

Pin #	SIGNALS
1	
2	TXD
3	RXD
4	
5	SG
6	
7	
8	
9	

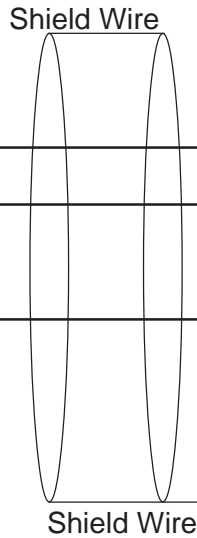

DB9 FEMALE PINOUTS

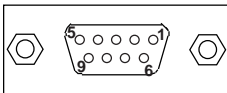

DB9 MALE PINOUTS

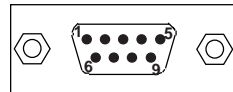

◆ **Cable Diagrams:**

4 Wire RS422/RS485 Cable connections:

**PLC SIDE or
4 Wire Network Side**

HIMOS SIDE



2 meter

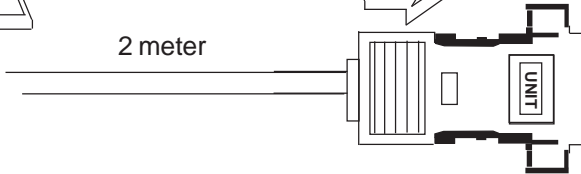

**DB9 MALE
(4 Wire RS422/485)**

SIGNALS	Pin #
RX+	YELLOW
TX+	GREEN
SG	BLACK
RX-	WHITE
TX-	BLUE

Shield Wire

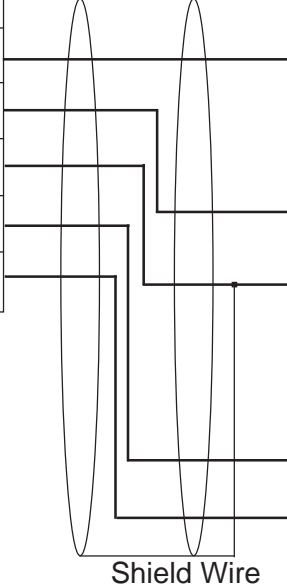

Pin #	SIGNALS
1	TX+
2	
3	
4	RX+
5	SG
6	
7	
8	TX-
9	RX-

Shield Wire

DB9 MALE PINOUTS

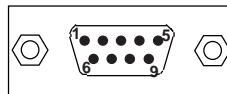

◆ **Technical Support**

For technical support please contact Ditel along with the unit serial number and revision number written on the address sticker of the unit. Also provide information of the PLC if used in application. Usually, including your application also provides a lot of help. If possible e-mail us the application.

Ditel Support:
Phone: (00 34) 93 339 47 58
Email: himos@ditel.es

Address:
DITEL (Diseños y Tecnología, S.A.)
P.I. Les Guixeres - C/ Xarol, 8-C
08915 Badalona, SPAIN
Website: www.ditel.es

MANUAL REVISION

If you contact us in reference to this manual, please include the following document details.

Name : Quick Start Manual For HI120X
Part Number : QSHO549
Document : QSHI120X\0407
Revision : 1.01

Revision Number	Document Number	Date	Description
Rev 1.00	30727319	20-09-2007	First Release.
Rev 1.01	30727319	20-12-2007	Sw image.

◆ **Cable Diagrams:**

2 Wire RS485 Cable connections:

