

DESCRIPTION

CAM SWITCH (3P+N 80A. ON-OFF SWITCH)

CONNECTION DIAGRAM

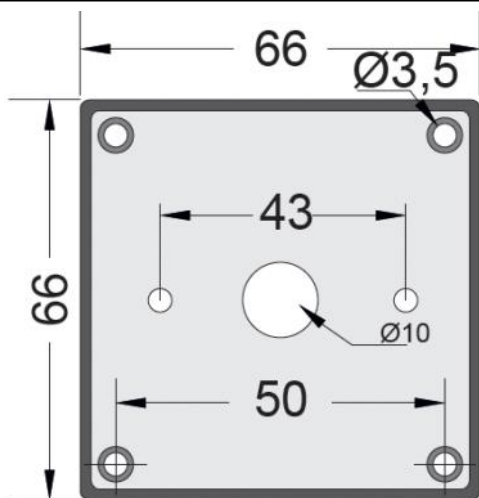
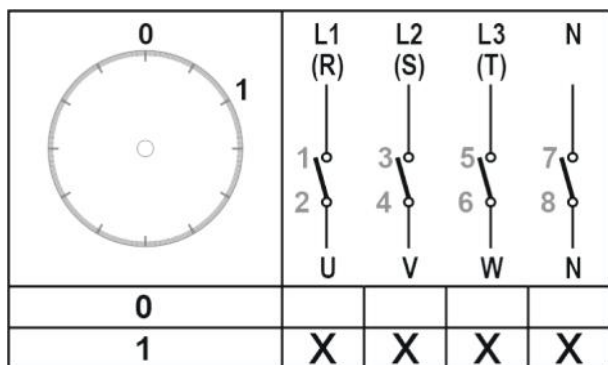

STANDARD FRAME

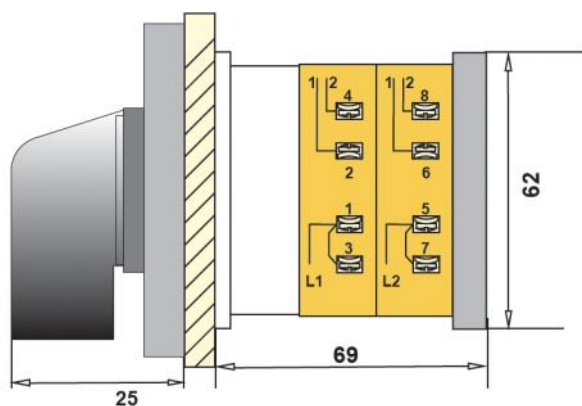

SIDE VIEW

TECHNICAL PROPERTIES

Class	AC-23A
Rated operational current (Ie)	80A
Rated insulation voltage (Ui)	690V
Rated operational voltage (Ue)	80A.400V AC/50-60Hz
Electrical Life	min. 10.000 cycles
Operating Temperature	-20 / +60 °c
Standard	EN 60947-3
Operation	4 Pole ON-OFF
Warranty Period	3 Years