

TEMPERATURE AND HUMIDITY MONITOR **HT20**



USER'S MANUAL

CE

Spis treści

1. Application.....	3
2. The set of the monitor.....	4
3. Basic requirements, operational safety.....	4
4. Assembly.....	5
4.1. Installation.....	5
4.2. External connections diagram.....	5
5. Operation.....	6
5.1. Messages after powering the monitor up.....	6
5.2. Functions of the button.....	7
5.3. Connection of the device – configuration.....	8
5.4. Functions of the monitor.....	11
5.5. Description of HT20 monitor reading field.....	11
5.6. Ethernet 10/100-BASE-T.....	13
5.6.1. Connection of 10/100 BASE-T interface.....	14
5.6.2. Ethernet interface default parameters.....	16
5.6.2.1. Changing the parameters of Ethernet interface.....	16
5.6.3 Web Server.....	17
5.6.3.1 General view.....	19
5.6.3.2. Selection of Web server user.....	21
5.6.3.3. Messages to the user.....	21
5.6.3.4. Access to the archive file through the web server.....	23
5.6.3.5 Logic alarms.....	23
5.6.4 FTP Server.....	25
5.6.4.1 Selection of FTP user.....	26
5.6.5 E-mail service.....	27
5.6.6 Modbus TCP/IP.....	30
5.6.6.1. Description of implemented functions.....	31
5.6.6.2. Map of registers.....	31
5.6.6.3. Read-only registers.	33
5.7. Firmware upgrade.....	34
5.8. Archiving measured values	36
5.8.1. The monitor memory structure.....	36
5.8.2. Configuration of archiving.....	37
5.8.3. File system internal memory.....	38
5.8.4. Structure of archive files.....	39
6. Additional accessories.....	40
7. Technical data.....	42
8. Ordering code.....	44

1. Application

HT20 monitor is designed for continuous measurement and conversion of relative humidity and ambient temperature into digital form (Modbus TCP/IP , HTTP protocols). The monitor programming is possible with the built-in web server. The monitor has an LCD display with 2x16 characters. The device allows you to send e-mail messages informing about the current environmental parameters as well as events that lead to exceeding the alarm values. The monitor is powered via Ethernet - PoE (Power Over Ethernet) or standard DC jack.

Features of HT20 monitor:

- measurement, display and archiving of ambient temperature, relative humidity, dew point and absolute humidity,
- signaling when set alarm values are exceeded
- programming logic alarm outputs with reaction to the selected input value.
- real-time clock function with clock supply support in case of the monitor power failure
- registration of input signals in programmed time
- Ethernet 10/100 BASE-T
 - protocol: Modbus TCP/IP, HTTP, FTP,
 - services: web server, ftp server, DHCP client, SMTP client,

Values measured and calculated by the monitor:

- ⇒ Temperature,
- ⇒ relative humidity,
- ⇒ dew point,
- ⇒ absolute humidity,

- Before turning on the monitor verify the connections.
- The monitor is intended for installation and use in industrial electromagnetic environments.
- A switch or a circuit-breaker should be installed in the building or facility. It should be located near the device, easily accessible to the operator, and suitably marked.

4. Assembly

4.1. Installation

HT20 monitor is mounted on a wall using a screw connection. The monitor housing consists of an upper and a lower part.

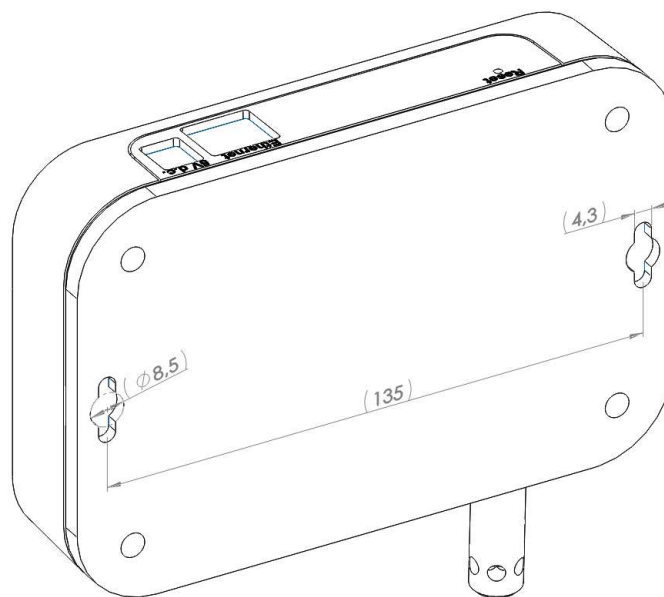

Fig.2 Location of mounting holes

4.2. External connections diagram

The monitor has 2 external slots:

- Ethernet port 10/100 base-T
- DC power socket $\phi 5.5 / 2.1$ mm

and 1 button to reset the device to standard parameters - "Reset"

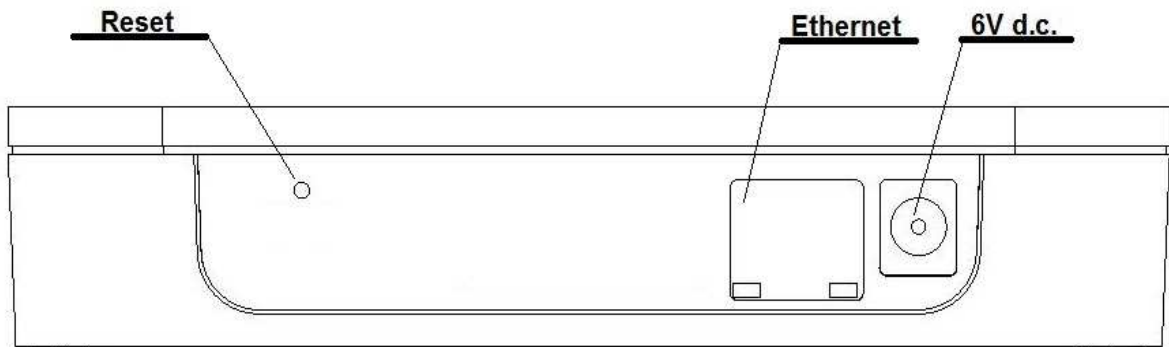

Fig.3 View of the upper part of HT20 monitor

5. Operation

After wiring, mounting and powering the monitor is ready to work with factory settings. The monitor can be programmed with the built-in web server.

The following parameters can be programmed in the monitor:

- Ethernet interface settings,
- Modbus settings,
- Archive settings,
- Alarm settings,
- SMTP client settings - e-mail (only as unencrypted connection)
- System settings.

Caution: Do not remove the cover of the sensor as this may damage the device!

5.1. Messages after powering the monitor up

After power is turned on the display shows the name of the device and the manufacturer and software version. After about 4s the serial number of the device is displayed and after another 4s the IP

address in the network, if the device has been connected to Ethernet network - the address can be static or obtained from DHCP server.

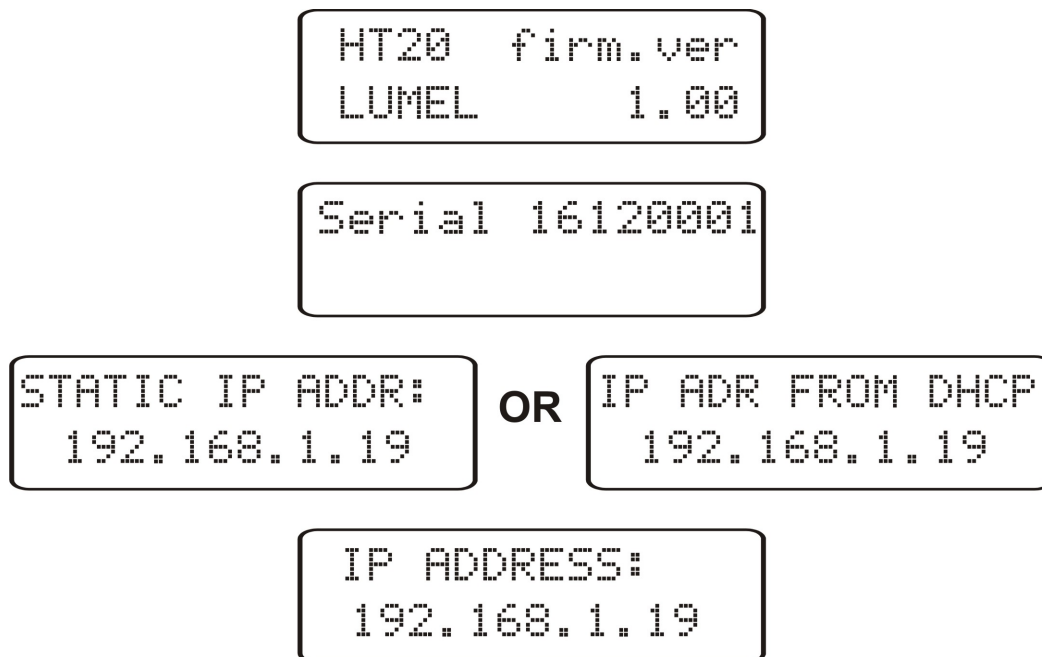

Fig. 4 Startup messages of HT20 monitor

5.2. Functions of the button

The device contains only one physical button for restoring the factory settings or displaying the current IP address of the monitor. This button is located on the connector panel – **fig. 3**.

- **restoring factory parameters** - after pressing and holding the button for 10 seconds; Note: each successive restoration of factory parameters enables or disables the service of obtaining network address from a DHCP server, i.e. if the DHCP service is enabled and restoring the factory parameters will be forced, the DHCP service will be disabled (you will be informed about the change with a message on the display) and the default static IP address will be assigned to the device: 192.168.1.19 (subnet mask:

255.255.255.0), another request for restoring the factory parameters will enable the DHCP server service - the network parameters will be obtained dynamically from the server;

- **displaying the current IP address of the monitor** – after a short press of the button – about 1 sec.

5.3. Connection of the device – configuration

5.3.1. Connection of the monitor to the network equipped with a DHCP server

The easiest way to connect an HT20 monitor to Ethernet is to use the existing DHCP server, which assigns communication parameters, i.e. IP address, subnet mask, gateway, DNS address to the devices being connected. In order to use the automatic configuration with a DHCP server, make sure the monitor is running with DHCP client service enabled - to do so, switch on the power of the monitor and observe the initial messages:

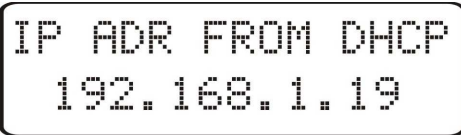
 a) message about the monitor operation with DHCP client enabled – the displayed IP address is the current address of the monitor acquired from DHCP server;

 b) message about the monitor operation with a DHCP client disabled – the displayed IP address is the current address of the monitor set manually or the default address (after restoration of default parameters); in order to obtain an address

from a DHCP server you must restore the monitor to factory defaults, p. 5.2, and restart the device - then you should see the message a) with the IP address acquired from DHCP server.

In order to further configure the device a computer (tablet, phone) must be connected to the same Ethernet network (also with DHCP client enabled - automatic acquisition of IP address), open a web browser and in the browser address field type the IP address displayed by HT20. This will display the login screen to log the web server that will allow further configuration - sign up to the administrator account, p. 5.6.3.2.

After gaining access to the full configuration we recommend that you disable the DHCP client, leaving the acquired network parameters unchanged – IP address, subnet mask, gateway, DNS address will be stored as static parameters.

5.3.2. Connecting the monitor to the network without using a DHCP server

In order to use the automatic configuration with a DHCP server, make sure the monitor is running with DHCP client service disabled - to do so, switch on the power of the monitor and observe the initial messages:

```
IP ADR FROM DHCP
192.168.1.19
```

a) message about the monitor operation with DHCP client service enabled – the displayed IP address is the current address of the monitor acquired from DHCP server; to set the a static IP address factory parameters

should be restored, p. 5.2, and the device should be restarted – then a message should be displayed b) with the static default IP address.



```
STATIC IP ADDR:  
192.168.1.19
```

b) a message about the monitor operation with disabled DHCP client service - the displayed IP address is the current address of the monitor set manually or the default IP address (after restoring the default parameters), if the displayed address is different from 192.168.1.19 the factory defaults should be restored twice, p. 5.2;

In order to further configure the device a computer (tablet, phone) must be connected to the same Ethernet network (or directly to the monitor) and the automatic acquisition of network parameters must be disabled. Then, the static parameters corresponding to the default network parameters of HT20 must be manually entered into the computer (tablet, phone) p. 5.6.2 (the same subnet mask and any IP address from the pool 192.168.1.X except for the address 192.168.1.19 assigned by default to HT20). After the connection, open your web browser and type the default IP address 192.168.1.19. in the address field of the browser. This will display the login screen to the web server of the monitor that allows further configuration – sign up to the administrator account, p. 5.6.3.2.

After logging in to the monitor web server it is possible to change the network parameters according to our needs - especially the IP address must be changed to make sure that the monitor does not

have the default IP address, otherwise the configuration of other monitors working in the same Ethernet network will be difficult.

5.4. Functions of the monitor

Monitor HT20 performs the following functions:

- measurement of the ambient temperature and relative humidity,
- calculation of selected physical quantities,
- memory of minimum and maximum values measured and calculated:
 - temperature,
 - relative humidity,
 - absolute humidity,
 - dew point.

5.5. Description of HT20 monitor reading field

HT20 is equipped with a backlit LCD display consisting of two lines of 16 characters each. The top line of the display is used for the presentation of measured values - temperature and relative humidity and to display status pictographs of the file system internal memory. The bottom line of the display is used for presentation of the state of the internal memory, alarm no. 1 status, time and date. During normal operation the monitor displays measured values alternately with their symbols.

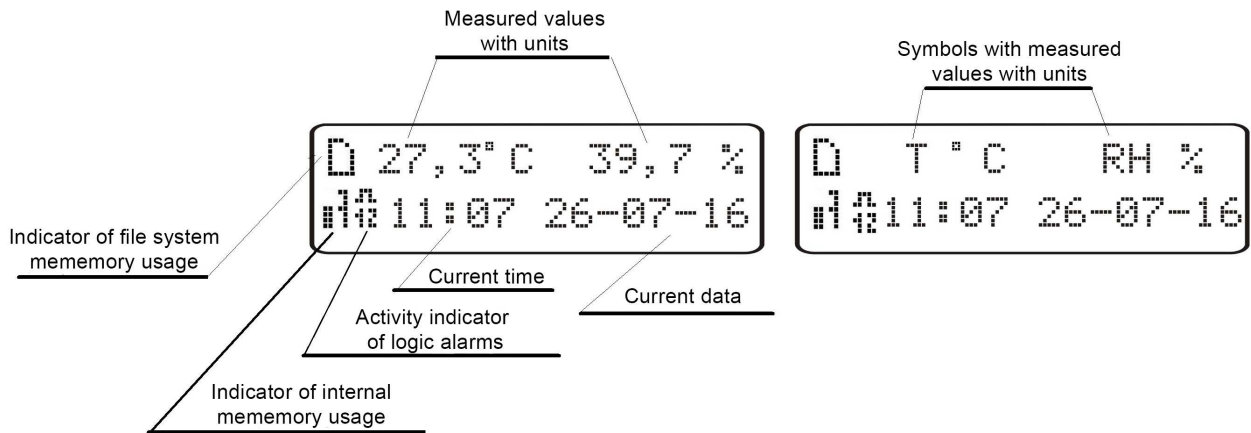

Fig. 5 Description of the monitor reading field

Tables 1, 2 show the symbols displayed on the LCD, and their meanings.

Table1

Symbol	Display mode	Meaning
	constant	file system internal memory installed and ready for operation
	flashing	error of file system internal memory
	flashing	file system internal memory full
	flashing	file system internal memory installed and ready for operation, active FTP connection
	constant	alarm activity indicator - alarms 1, 2 active
	constant	alarm activity indicator - alarm 1 active
	constant	alarm activity indicator - alarm 2 active
	constant	alarm activity indicator - alarms inactive

Table2

Symbol								
Percentage of internal memory usage	87.5...100%	75...87.5%	62.5...75%	50...62.5%	37.5...50%	25...37.5%	12.5...25%	0...12.5%

When measuring ranges are overrun it is indicated by displaying special characters on the top line of the LCD:

- - lower overrun of the range of the displayed value
- - upper overrun of the range of the displayed value

5.6. Ethernet 10/100-BASE-T

HT20 monitors are equipped with Ethernet interface for the connection (using RJ45 slot) to a local or global network (LAN or WAN) and the use of network services implemented in the monitors: Web server, FTP server, Modbus Slave TCP/IP, SMTP client. In order to use the network services Ethernet parameters of the monitor must be configured. Standard Ethernet parameters of the monitor are shown in **Table 4**. The basic parameter is the IP address of the monitor - by default 192.168.1.19, which must be unique within the network to which we connect the device. The IP address can be assigned to the monitor automatically by DHCP server present on the network provided that the option to acquire IP address from DHCP server is enabled. DHCP service is disabled by default, then the monitor initializes with the default IP address

allowing the user to change the IP address through the website.

Note: The monitor allows for up to 10 connections simultaneously!! The applications implemented in the monitor use from 1 to 2 connections:

- Modbus TCP/IP - 1 connection
- Web server - minimum 1 connection
- FTP server - 2 connections
- SMTP client - 1 connection

5.6.1. Connection of 10/100 BASE-T interface

To access the Ethernet services, it is required to connect the monitor to the network via the RJ45 slot located at the top of the monitor, operating in accordance with TCP/IP.

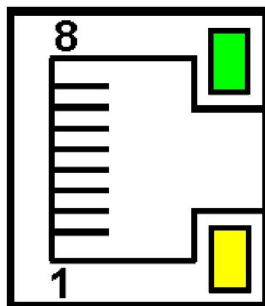

Fig.6 View and numbering of RJ45 slot pins

Description of the monitor RJ45 slot diodes function:

- yellow LED - illuminates when HT20 is properly connected to the Ethernet network 100 Base-T, does not light up when HT20 is not connected to the network or is connected to 10-Base-T network.
- green LED - Tx/Rx flickers when the monitor sends and receives data, illuminates constantly when data is transmitted

In order to connect HT20 to the network the User should use

twisted pair cable.

- U/FTP – twisted pair cable with each pair foiled,
- F/FTP – twisted pair cable with each pair foiled, additionally cable with foil shield,
- S/FTP (formerly SFTP) – twisted pair cable with each pair foiled, additionally cable with wire mesh shield,
- SF/FTP (formerly S-STP) – twisted pair cable with each pair foiled, additionally with foil and wire mesh shield,

Categories of twisted pair cable according to the European standard EN 50173 minimum: Class D (category 5) - for high-speed local area networks, includes applications using the frequency band up to 100 MHz. The description of the connection is shown in Table 3. For Ethernet interface the User should use twisted pair cable of STP type (shielded) category 5 with RJ-45 connector with conductors in colors (in accordance with the colors described in table 3) acc. to the following standard:

- EIA/TIA 568A for both connectors at the so-called simple connection of HT20 to the network hub or switch,
- EIA/TIA 568A for the first connector and EIA/TIA 568B for the second connector at the so-called patch cord connection (crossover) used, among others, when connecting HT20 to a computer.

Table 3

Conduct or no.	Signal	Conductor color acc. to standard	
		EIA/TIA 568A	EIA/TIA 568B
1	TX+	white-green	white-orange
2	TX-	green	orange

3	RX+	white-orange	white-green
4	EPWR+	blue	blue
5	EPWR+	white-blue	white-blue
6	RX-	orange	green
7	EPWR-	white-brown	white-brown
8	EPWR-	brown	brown

5.6.2. Ethernet interface default parameters

Table 4

No.	Name	Default value
1.	DHCP	Enabled or disabled (cycled when default parameters restoration is forced)
2.	IP Address	192.168.1.19
3.	Subnet mask	255.255.255.0
4.	Gateway	192.168.1.1
5.	DNS	8.8.8.8

5.6.2.1. Changing the parameters of Ethernet interface

Changing the parameters of the Ethernet interface is possible through the built-in web server.

Ethernet
Settings preview

Passwords Ethernet FTP server Settings Modbus TCP

SMTP/HTTP

Adress IP 192.168.1.186

Subnet mask 255.255.255.0

Gateway 192.168.1.20

DNS ip address 192.168.1.20

Mac adress 0C:EF:AF:20:02:C9

Transmission speed: Auto

DHCP: ON OFF

Apply changes

Save Close

Fig.7 View of the window to change the parameters of the Ethernet interface

5.6.3 Web Server

Monitor HT20 provides its own Web server that allows remote monitoring of measured values and remote configuration and readout of the monitor status. With the web page the user can:

- obtain device information (serial number, execution code, firmware version, bootloader version, variant (standard or special),
- preview the current measured values,
- read the status of the device,

- select the language for the Web page,
- perform configuration

Access to the Web server is achieved by entering the monitor IP address in the web browser, e.g. : http://192.168.1.19 (where 192.168.1.19 is set at the monitor). The standard port for web server is port "80". Server port may be changed by the user.

Note: For proper web page operation a browser with JavaScript enabled and compatible with XHTML 1.0 is required (all popular browsers, Internet Explorer, version 8 minimum).

5.6.3.1 General view

00:04:58 - to logout



LUMEL

EVERYTHING COUNTS



HT20

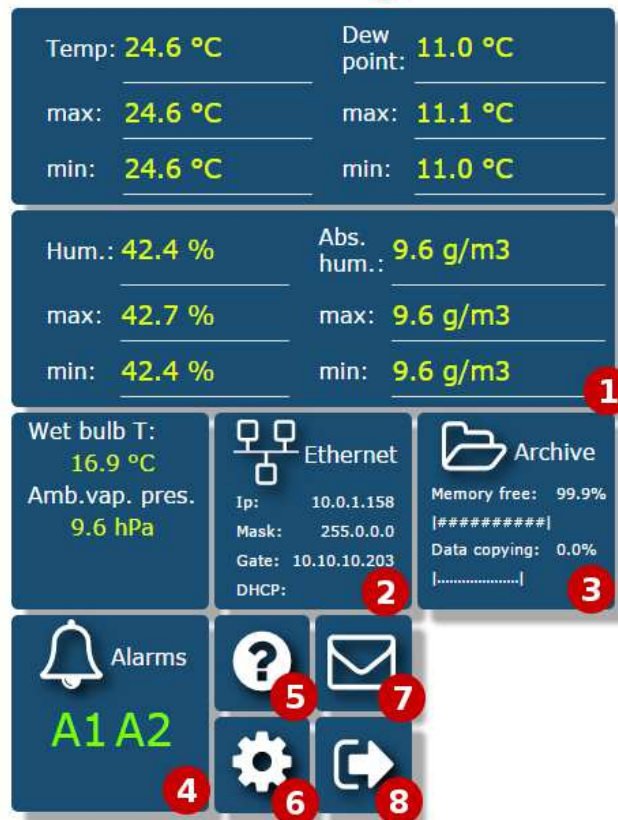

Copyright © 2016, Lumel S.A. All rights reserved.

Fig.8 General view of the main website

The function of each tile of the website:

- 1)The view of measurements and after clicking on the tile graphs with trends are displayed.
- 2)Ethernet interface settings.
- 3)Archive settings and information about memory usage and the process of data dump to the file system memory.
- 4)Alarm settings and information about their status.
- 5)Information about the device, giving an individual name to the monitor.
- 6)Setting the time, LCD display and configuration of our displayed values - the groups of any of the 12 values of the monitor registers

to which we can assign our own name and display it as a separate tile on the website. Defined records can be archived and they control the alarms.

- 7)Email configuration.
- 8)Logging off, return to the login page.
- 9)Configurable device name
- 10) Changing the language
- 11) Time to log off when inactive

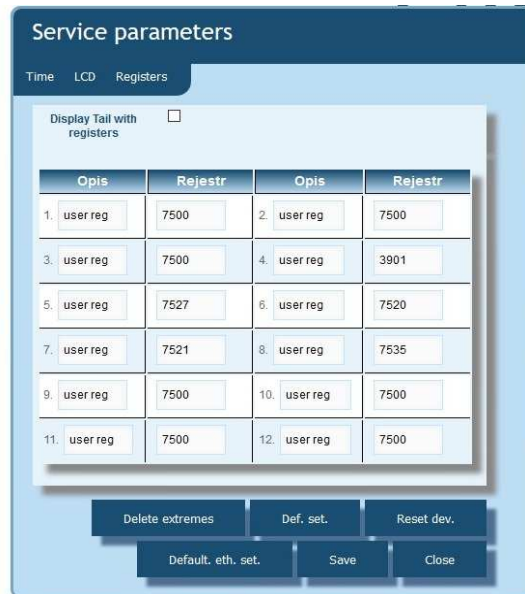

Fig.9 View of the window to configure the groups of our own records

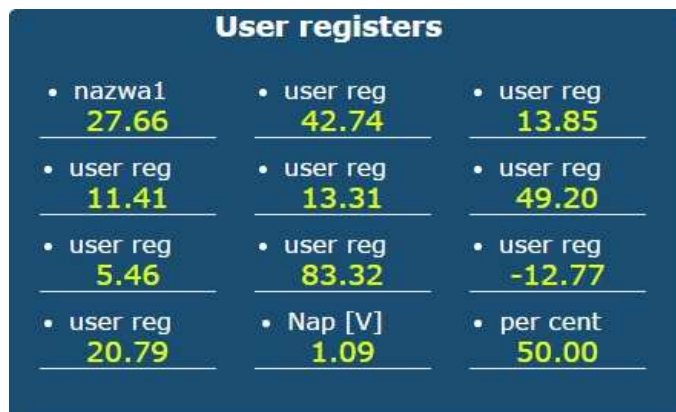

Fig.10 View of a tile displaying a group of our 12 values

5.6.3.2. Selection of Web server user

The monitor has two user accounts for the Web server secured by individual passwords:

- user: "**admin**", password: "**admin**" - access to configuration and the preview of parameters
- user: "**user**", password: "**pass**" - access to the preview of parameters only.
- user: "guest" - access to the preview of the measured values on the home page only, log on to the guest account does not require entering a user name or password, it is enough to select "Login as a guest" and then click on "Login"



Fig.11 View of the login window to the website

Calling the monitor's IP address in the browser, for example <http://192.168.1.19> will display the start display in the browser where the user must enter name and password. Additionally, you can log in to the "guest" account, when you select "Login as a guest" on the login page. "guest" user account is limited to view the measured values on the main page. Log off occurs after 5 minutes of inactivity.

5.6.3.3. Messages to the user

The web server is equipped with a system of messages

to the user. If the user tries to save the settings into the monitor, a message is returned on the status of such operation. For mobile applications there is a user notification system built-in the web browser.



Fig.12 View of the message window informing that parameters have been correctly recorded in the device



Fig.13 View of the message window informing about incorrect data of the web form



Fig. 14 View of the message window informing about lack of permission to view the website content.

5.6.3.4. Access to the archive file through the web server

HT20 allows for access to archive files through the file manager implemented on the web server that allows the user to retrieve and delete individual files. To start the archive file manager, click on the tile **Archive**, and then click the button **Browse arch. Files**.

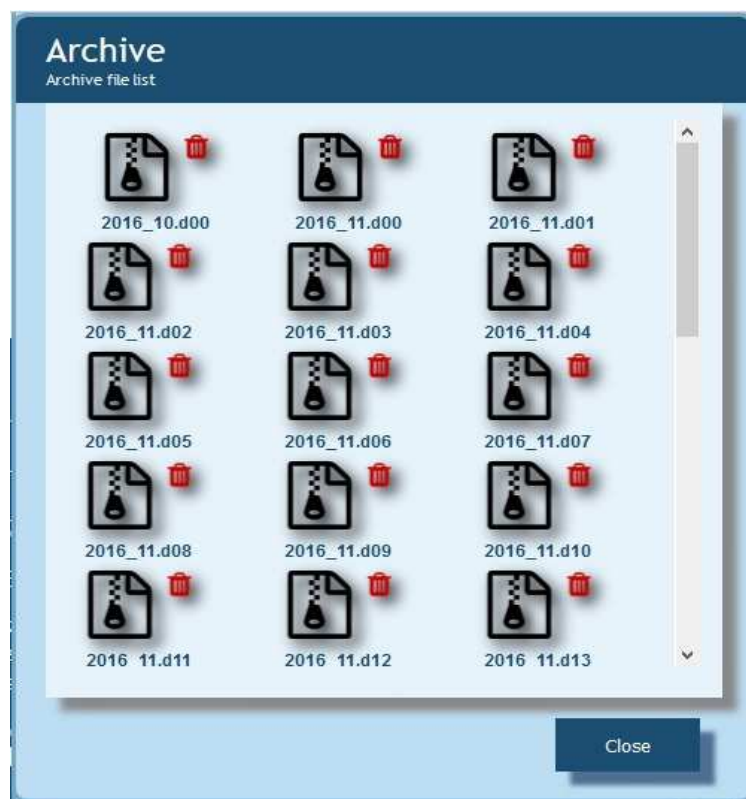

Fig.15 View of the window of the file manager on the web server

In order to download the file, click the file icon, and to delete a file, click the trash can symbol next to the file icon.

5.6.3.5 Logic alarms

HT20 is equipped with 2 logic alarm outputs. Each alarm can

operate in one of six modes. **Fig. 17** shows the operation of alarm in the following modes: n-on, n-off, on, off. The other two modes: h-on and h-off mean respectively, always On and always Off. These modes are designed for manual simulation of alarm states.

The screenshot displays the 'Alarms' configuration window. At the top, the title 'Alarms' is shown in a dark blue header. Below the header, there is a dropdown menu labeled 'Choose setting' with the selected option 'Alarm 1 configuration settings'. The main configuration area consists of several rows of controls:

- 'Alarm control parameter': A dropdown menu set to 'Temperature'.
- 'Alarm working mode': A dropdown menu set to 'h-off', accompanied by an information icon (i).
- 'Alarm threshold - lower val.': A text input field containing '20.1'.
- 'Alarm threshold - upper val.': A text input field containing '20.1'.
- 'Alarm ON delay [s]': A text input field containing '0', with an information icon (i).
- 'Alarm Off delay [s]': A text input field containing '0', with an information icon (i).
- 'Re-switching alarm delay [s]': A text input field containing '0', with an information icon (i).
- 'Alarm output (use CTRL to check many)': A list box containing 'Buzzer', 'E-mail Adress1', and 'E-mail Adress2', with 'E-mail Adress1' selected.

At the bottom right of the window, there are two buttons: 'Save' and 'Close'.

Fig. 16 View of alarms configuration window

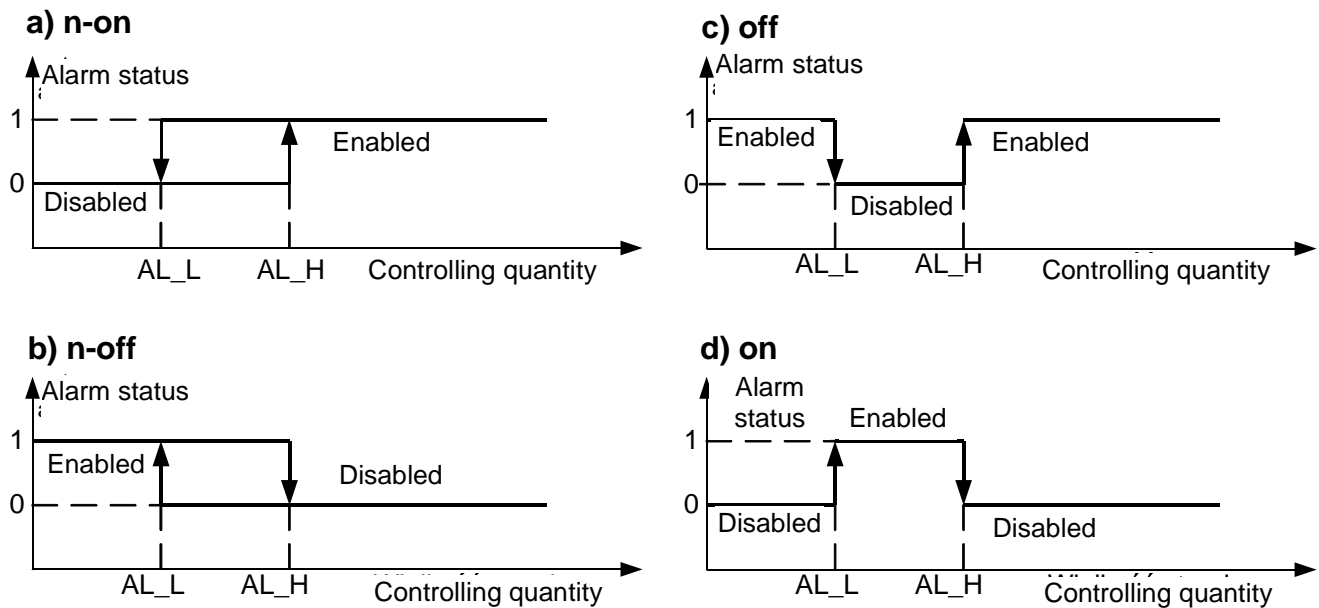

AL_L - Lower threshold of the alarm
 AL_H - Upper threshold of the alarm

Fig. 17 Types of alarms: a) n-on; b) n-off; c) on; d) off.

Note: In the case of alarm types n-on, n-off, on, off entering $AL_L > AL_H$ will disable the alarm.

In the "alarm output" tab the user can decide what action will be performed following the change of the alarm state:

- **Buzzer** – audible alarm
- **E-mail address 1** – sending an e-mail to recipient No. 1
- **E-mail address 2** – sending an e-mail to recipient No. 2

It is possible to simultaneously select several options at once.

Note: If the user selects the audible alarm for alarm number 1 (2), the same option should not be selected for alarm 2 (1).

5.6.4 FTP Server

FTP file sharing protocol is implemented in HT20 monitors. The monitor acts as a server, allowing clients to access the internal memory of the meter file system. Access to files is possible using a computer, tablet with installed FTP client or another device acting

as FTP client. To transfer files using FTP the following ports are normally used: "1025" - data port and "21" - command port. If necessary, the user can change the port used by the FTP. Please note,

that the configuration of the server and FTP client ports must be the same.

FTP client program should work in passive mode, then the connection is established fully by the client (the customer chooses the data port). For file transfer with the monitor it is possible to use maximum one connection at the same time, that is why the maximum number of connections must be limited to "1" in the client program.

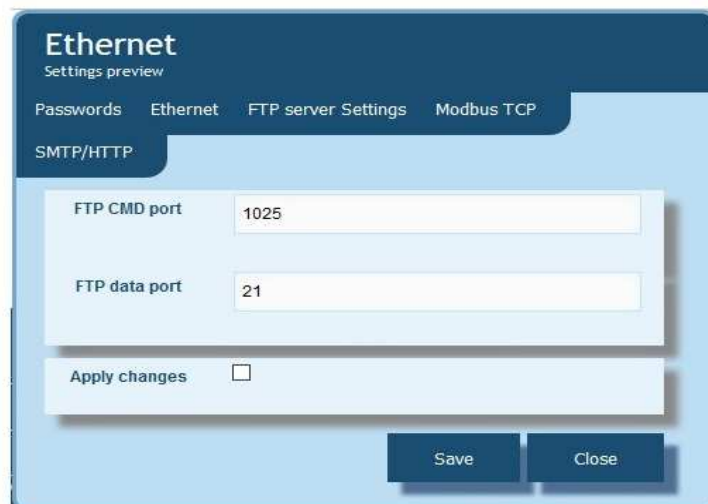

Fig.18 View of FTP ports configuration window

5.6.4.1 Selection of FTP user

The monitor has two user accounts for the FTP server secured by individual passwords:

- user: "**admin**", password: "**admin**" - access to saving and reading

files

•user: "**user**", password: "**passftp**" - access to reading archive files only.

FTP user names cannot be changed, however, it is possible to change the password for each user - it is recommended to change passwords for security reasons. The password must contain a minimum of 4 characters. Password change is only possible through the web page in "Ethernet" parameters group. Passwords can have a maximum of 8 characters. If the password is lost - making it impossible to use the FTP, the factory defaults of the Ethernet interface must be restored through the Web site, or all settings can be restored to the factory defaults using the "Reset" button. 4.2. All standard parameters of the monitor including the Ethernet parameters and password for FTP server users will be restored:

user "**admin**" → password: "**admin**";

user "**user**" → password "**passftp**".

FileZilla can be used as the FTP client. By typing the monitor IP address in the address field we can view and download archive files.

5.6.5 E-mail service

HT20 monitors have been equipped with a function to send email messages using SMTP. To send a message a user must provide authentication data to SMTP proxy server. It is recommended that the server is located in the same network as the device.

Caution:**SMTP proxy server must support AUTH PLAIN authentication for unencrypted connection.**

The service allows a user to send information about alarm events and information in the form of regular short e-mail messages that contain the following information:

- The time at which the event occurred,
- The quantity that caused the event,
- The measured values which occurred at the moment of alarm status change,
- The name of the device from which the information was sent.

HT20 monitor has a memory buffer allowing for storage of maximum 20 e-mail messages. If an e-mail cannot be sent on a regular basis, for example, due to lack of connection they are queued up one after the other until their number exceeds 20.

When the limit is exceeded, the subsequent messages will be lost. In the case of transmission errors, wrong configuration or other factors beyond the control of the device (e.g. Anti-spam protection of SMTP server) messages may not reach their destination.

- 1)SMTP server address, for example, "smtp.wp.pl"
- 2)Address of the sender, .eg. "MyName@gmail.com"
- 3)Username registered on the SMTP server
- 4)The password for the specified account on the SMTP server
- 5)The name of the first recipient to which the message is to be delivered
- 6)The name of the second recipient

7) The period of sending regular messages

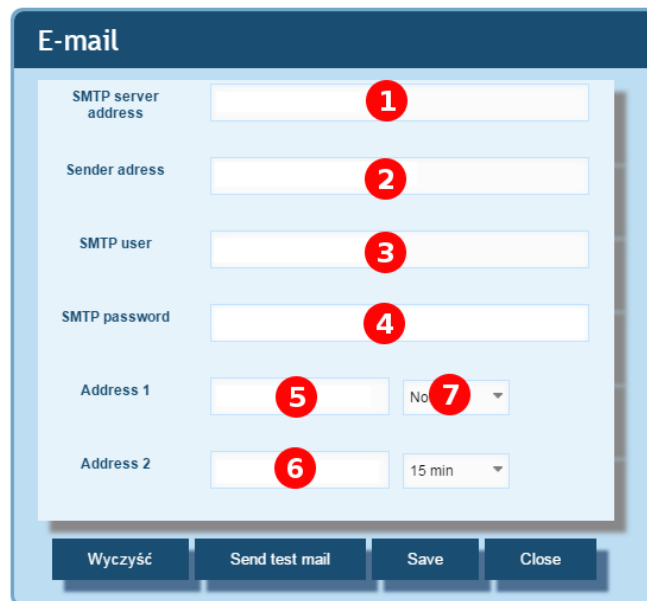

Fig. 19 View of e-mail configuration window

The correct SMTP server port must be configured at "Ethernet" tile in "SMTP" tab. For unencrypted connections usually ports 25 or 587 are used.



Fig. 20 View of SMTP port configuration window on "Ethernet" tile

To verify the configuration of e-mail, click on the "Send a test message" button on "E-mail" tile and then, in order to determine the configuration errors, watch the messages appearing in the upper left corner of the website.

5.6.6 Modbus TCP/IP

HT20 monitors allow access to internal registers via Ethernet and Modbus TCP/IP Slave. Modbus protocol functions and structure of the records are described in points 5.5.6.1 – 5.5.6.3. In order to set up a connection it is necessary to set a unique IP address for the monitor and to set the connection parameters listed in Table 5.

Table 5

No.	Description	Default value
1 .	Device address for MODBUS TCP/IP	1
2 .	Port number of Modbus TCP	502
3 .	Time to close the port of Modbus TCP/IP service [s]	60
4 .	The maximum number of simultaneous connections to Modbus TCP / IP service	2

The device's address is the address of the device for Modbus TCP / IP. By setting the address of the monitor to "255" the monitor will skip the analysis of the address in Modbus frame (broadcast mode).

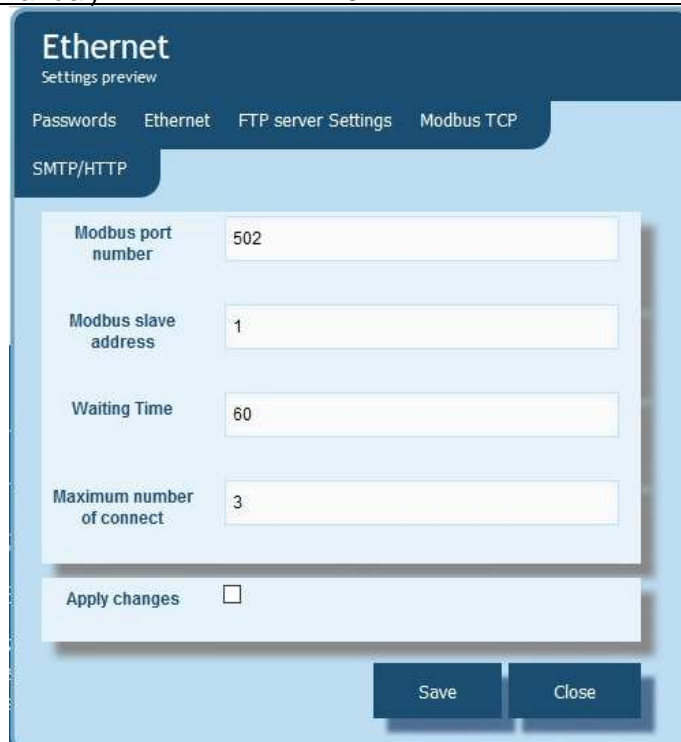

The screenshot displays the 'Ethernet' settings page with a 'Settings preview' header. A navigation bar includes 'Passwords', 'Ethernet', 'FTP server Settings', and 'Modbus TCP'. Below this, a sub-tab labeled 'SMTP/HTTP' is active. The main configuration area contains four input fields: 'Modbus port number' (502), 'Modbus slave address' (1), 'Waiting Time' (60), and 'Maximum number of connect' (3). At the bottom left, there is an 'Apply changes' checkbox which is currently unchecked. At the bottom right, there are two buttons: 'Save' and 'Close'.

Fig.21 View of Modbus TCP configuration parameters on "Ethernet" tile

The implemented protocol is in accordance with the standard PI-MBUS-300 Rev G of Modicon Company.

5.6.6.1. Description of implemented functions

HT20 monitors have the following MODBUS functions:

- 03 (03h) – readout of group of register.
- 04 (04h) – readout of group of input registers.
- 17 (11 h) - identification of slave device.

5.6.6.2. Map of registers

In HT20 monitor the data is placed in 16- and 32-bit registers. Process variables and parameters of the monitor are located in the address space of registers in a manner dependent on the type of the variable. Bits in 16-bit registers are numbered from the

youngest to the oldest (b0 ... b15). 32-Bit registers (4 Bytes) contain floating point numbers in IEEE-754 standard. Order of bytes: B3 B2 B1 B0 – the oldest byte is sent first. 16-Bit registers representing 32-bit values in two subsequent registers are doubled in another address area with the following bytes order: B1 B0 B3 B2 (Tab. 6).

The map of HT20 registers is presented below.

Note: All given addresses are physical addresses. In some computer programs, logical addressing is applied, then addresses must be increased by 1.

Table 6

Address range	Value type	Description
6000-6198	float (32 bits)	Value is placed in two successive 16-bit registers. Registers contain the same data as 32-bit registers of 7500 range. Registers are read-only. Bytes order (B1,B0,B3,B2)
7000 -7198	float (32 bits)	Value is placed in two successive 16-bit registers. Registers contain the same data as 32-bit registers of 7500 range. Registers are read-only. Bytes order (B3,B2,B1,B0)
7500-7599	float (32 bits)	Value is placed in 32-bit register. Registers are read-only.

5.6.6.3. Read-only registers.

Table 7

Value is placed in two successive 16-bit registers. These registers contain the same data as 32-bit registers of 7500 range.	Value is placed in 32-bit registers.	Name	Record (o) readout/ (z)	Unit	Unit name
7000/6000	7500	T	o	°C	Measured temperature
7002/6002	7501	RH	o	%	Measured relative humidity
7004/6004	7502	DP	o	°C	Calculated dew point
7006/6006	7503	AH	o	g/m ³	Calculated absolute humidity
7008/6008	7504		o	°C	Wet bulb temperature
7010/6010	7505		o	hPA	Saturated vapor pressure
7012/6012	7506				Enthalpy
7014/6014	7507				Reserved
7016/6016	7508				Reserved
7018/6018	7509				Reserved
7020/6020	7510	min T	o	°C	Minimum temperature
7022/6022	7511	max T	o	°C	Maximum temperature
7024/6024	7512	min RH	o	%	Minimum relative humidity
7026/6026	7513	max RH	o	%	Maximum relative humidity
7028/7028	7514	min DP	o	°C	Minimum dew point
7030/6030	7515	max DP	o	°C	Maximum dew point
7032/6032	7516	min AH	o	g/m ³	Minimum absolute humidity
7034/6034	7517	max AH	o	g/m ³	Maximum absolute humidity
7036/6036	7518		o		Device ID
7038/6038	7519				Status
7040/6040	7520				% of internal archive usage
7042/6042	7521				Reserved
7044/6044	7522				Progress of internal archive rewriting To the file system
7046/6046	7523	Current	o	-	Current time

		time			
7048/6048	7524	Date - year	o	YYYY	Current date - year
7050/6050	7525	Month, day	o	MMDD	Current date - month, day
7052/6052	7526				Reserved
7054/6054	7527		o		the amount of file system memory available space (kB), value "-1" means a memory error
7056/6056	7528		o		Total storage capacity of file system memory (kB), value "-1" means no properly installed memory
7058/6058 ...7072/6072	7529- 7536		o		Reserved
7074/6074	7537		o		The first defined register displayed
7076/6076	7538		o		The second defined register displayed
7078/6078	7539		o		The third defined register displayed
...
7096/6096	7548		o		The twelfth defined register displayed

5.7. Firmware upgrade

HT20 monitors implements a feature that allows the user to upgrade the software using a PC. Free eCon software and update files are available on the www.lumel.com.pl. RS-485 to USB converter connected to a computer is needed to perform the upgrade, e.g.: PD10 converter.

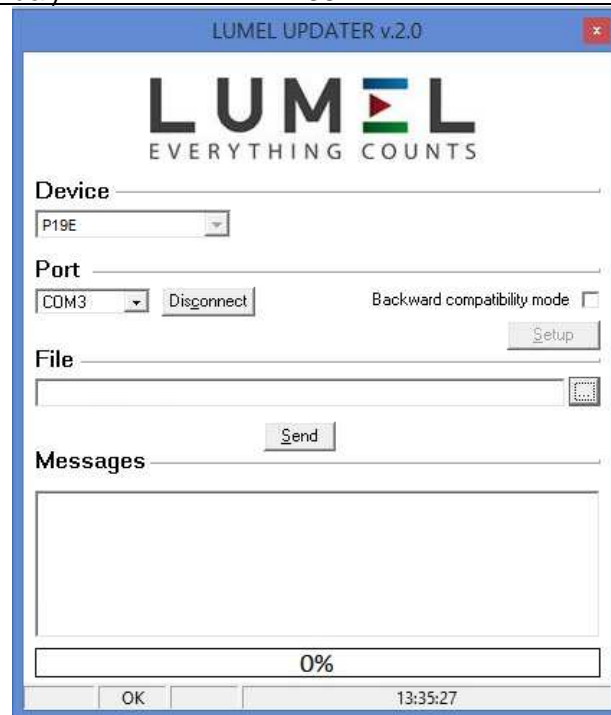

Fig. 22 View of the program to upgrade the firmware.

Caution! After upgrading the software, set up the factory setting of the monitor.



Prior to the upgrade, remove the housing of the device and connect the RS-485 conductors to the connector marked "BA"

After starting the eCon program the speed, mode, the monitor IP address and RS-485 port must be set in the **Communication** tab.

Then click the **Connect** icon. Then click the link **Upgrade firmware** which will display the window of LUMEL UPDATER (LU) – **Fig. 22**.

Click the **Connect** button. **Messages** information window contains info

about the progress of the upgrade process. When the port is properly opened the display shows: **Port opened**. Switching to the upgrade mode is performed remotely via LU (based on the settings in eCon or the website - address, mode, speed, COM port) - upgrade according to the recommended communication

parameters, i.e. speed 115200 kb/s, 8N2 mode. If the monitor establishes communication with LUMEL UPDATER the following message is displayed in LU program **Device found: HT20** and the version of the main program and the bootloader of the connected device, and the monitor display will show the message "Device is ready." Then, by pressing the „ ... ” button, load the file with the new version of the software in LUMEL UPDATER. When the file is properly opened, LU program displays information **File opened**. Press the **Send** button. When upgrading the percentage of the upgrade progress is displayed in the bottom line. After successful upgrade the monitor switches to normal operation, and the information window shows **Done** and the upgrade duration.

The current software version can also be checked by reading the greeting messages of the monitor after powering up.

Note: Software upgrade is only possible when the monitor is directly connected to PC (no other **Master** devices connected to RS-485).



Caution: Turning off the power during the software upgrade may result in permanent damage to the monitor!



5.8. Archiving measured values

5.8.1. The monitor memory structure

HT20 monitors are normally equipped with 4MB of internal memory for storing current data recorded by the monitor. The monitor can record any parameter of the 4 measured values - temperature, relative humidity, dew point and absolute humidity. Additionally, a

user can archive each of 12 defined displayed quantities. Internal memory of the monitor allows for storage of 534336 records. If the default 50% of the internal memory is used (or other value defined by the user) the archive is automatically rewritten to the file system memory. The memory is a circular buffer. After the memory is full, the oldest data is overwritten. The internal archive can be read, copied and deleted.

HT20 monitors have file system internal memory of the size of 8GB (memory size of the file system can be increased on request or according to the needs of the manufacturer) to which the data from the internal memory are automatically rewritten in the form of files. Data can be downloaded via Ethernet using FTP or Web site.

Minimum archiving period is 10 seconds.

5.8.2. Configuration of archiving

Website is used to configure the archiving parameters. Archiving can be continuous and conditional. Triggering conditional archiving may be performed according to one of the four possibilities shown in **Fig. 23** (n-on, n-off, off, on). Continuous archiving is activated by selecting h-on archiving type, and it is turned off by selecting the h-off option.

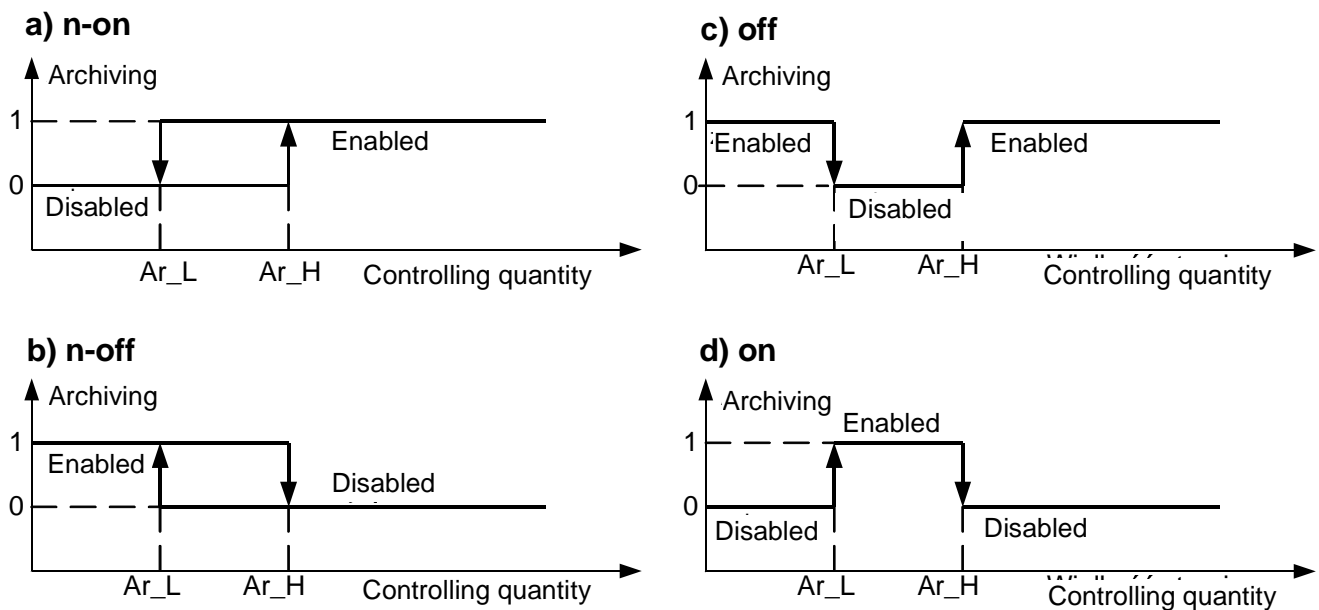

Fig. 23 Types of conditional archiving

Ar_L - Lower threshold of archiving

Ar_H - Upper threshold of archiving

5.8.3. File system internal memory

HT20 monitors are equipped with file system internal memory. FAT and FAT32 file systems are supported. During operation the monitor creates file directories containing historical data.

During registration the monitor creates directories and files of the file system in the internal memory. An example of the directory structure is shown in **Fig. 24**.



Fig. 24 Directories structure in the memory.

Apart from the ARCH directory, in which the archived data is placed, SYSTEM directory is also created on the card where the following files are located:

- start.txt - date and time of the file system internal memory installation (when the monitor is restarted after power failure)
- manual.pdf - current user's manual
- enarch.gif – graphic file with info about alarms / archiving configuration

Note: If these files are deleted, some elements of the website - hints, instructions, may not be displayed; these files can be removed after logging in FTP server to admin account.

Data in the memory is stored in files located in the directories with names corresponding to the device name and the serial number - see Fig. 24. Whereas the names of the files correspond to the date of recording and they have the following format *XXXX_YY.Dzz*, where *XXXX* → year , *YY* → month. The format of the archive file extension is *Dzz*, where "zz" is the subsequent number of the archive file from a given month. For example, the first file in the archive in the month of May 2016 will be 2016_05.D00, the next file: 2016_05.D01 etc. For a given month it is possible to create maximum 32 files (*.D00 ... *.D31). The file is changed automatically when the file size reaches 29 MB.

5.8.4. Structure of archive files

Files containing archived data in the internal memory of the file system are structured as columns, where successive columns of data are separated from each other by a tab character. The first line of the file contains the columns header. Data records are sequentially arranged in rows and the fields of the record are

separated from each other by a tab character. View a sample archive file with archiving of further 12 user's displayed values is shown in **Fig. 25**.

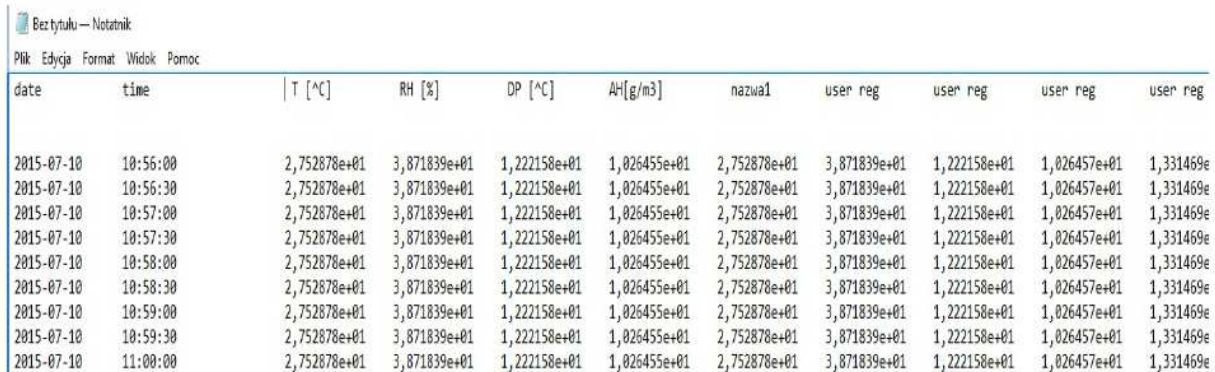

date	time	T [°C]	RH [%]	DP [°C]	AH[g/m3]	nazwa1	user reg	user reg	user reg	user reg
2015-07-10	10:56:00	2,752878e+01	3,871839e+01	1,222158e+01	1,026455e+01	2,752878e+01	3,871839e+01	1,222158e+01	1,026457e+01	1,331469e
2015-07-10	10:56:30	2,752878e+01	3,871839e+01	1,222158e+01	1,026455e+01	2,752878e+01	3,871839e+01	1,222158e+01	1,026457e+01	1,331469e
2015-07-10	10:57:00	2,752878e+01	3,871839e+01	1,222158e+01	1,026455e+01	2,752878e+01	3,871839e+01	1,222158e+01	1,026457e+01	1,331469e
2015-07-10	10:57:30	2,752878e+01	3,871839e+01	1,222158e+01	1,026455e+01	2,752878e+01	3,871839e+01	1,222158e+01	1,026457e+01	1,331469e
2015-07-10	10:58:00	2,752878e+01	3,871839e+01	1,222158e+01	1,026455e+01	2,752878e+01	3,871839e+01	1,222158e+01	1,026457e+01	1,331469e
2015-07-10	10:58:30	2,752878e+01	3,871839e+01	1,222158e+01	1,026455e+01	2,752878e+01	3,871839e+01	1,222158e+01	1,026457e+01	1,331469e
2015-07-10	10:59:00	2,752878e+01	3,871839e+01	1,222158e+01	1,026455e+01	2,752878e+01	3,871839e+01	1,222158e+01	1,026457e+01	1,331469e
2015-07-10	10:59:30	2,752878e+01	3,871839e+01	1,222158e+01	1,026455e+01	2,752878e+01	3,871839e+01	1,222158e+01	1,026457e+01	1,331469e
2015-07-10	11:00:00	2,752878e+01	3,871839e+01	1,222158e+01	1,026455e+01	2,752878e+01	3,871839e+01	1,222158e+01	1,026457e+01	1,331469e

Fig. 25 Sample data file



Subsequent fields included in a row describing the record have the following meanings:

- *date* – the date of the data registration, the date separator character is "-"
- *time* – hour, minute, second of the recorded data, time separator character is ":"
- *T, RH, DP, AH, name1, user reg, ...* – name of the value to be archived, the default separator character is "." however, the separator can be changed to ",", by selecting the proper option in the Archive window of the website.

6. Additional accessories

HT20 monitors are available with additional accessories such as D.C. and PoE IEEE 802.3af. power supply units Table 7 shows the available items with their codes.

Table 8

No.	Accessory	Appearance	Ordering code	Technical data
1.	6 VDC power supply unit		20-072-00-00094	<p>Voltage: 6 V d.c. \pm 5% Maximum power: 6W* Input voltage: 90...253 V a.c. Operating temperature: 0...40°C* Dimensions: 63.6 x 29.5 x 45.6 mm* Conductor length: 1.4 m \pm 10%* Plug: ϕ5.5 / 2.1 mm *power supply parameters can change</p>
2.	PoE power supply		20-090-00-00022	<p>Input voltage: 100 – 240 VAC Input frequency: 47 – 63 Hz Current consumption: 0.35 A max. for 240 VAC Output voltage: 48 VDC Power output: 15.4 W Operating temperature: 0 – 40°C Dimensions: 140 x 65 x 36 mm Weight: 0.2 kg</p>
3.	power cord for PoE power supply		20-069-00-00146	conductor length: 1.8 m

7. Technical data

Basic parameters:

–measuring range of relative humidity (RH)

0...95 % without condensation

–intrinsic error of humidity processing

±3% of the range for RH = 10...90%

±5% in the remaining range

–hysteresis humidity measurement

± 1% RH

–basic range of temperature measurement (T)

– 20...60 °C

–intrinsic error of temperature processing

±0.6° C in the range of 10...40° C

±1.0° C in the remaining range

–calculated quantities absolute humidity (a) [g/m³]

dew point temperature (Td) [°C]

Ethernet Interface: 10/100-Base-T

- max. number of simultaneous connections 10

Nominal operating conditions:

– power supply

6 V d.c.

or PoE IEEE 802.3af

– power consumption

< 2 VA

–ambient temperature

– 20...23...60 °C

–air relative humidity:

< 95%

–time of initial warm-up	15 minutes
–degree of protection provided by housing	IP 20
– mounting	on a wall
– weight	<0.3 kg
–dimensions	(120 x 80 x 25) mm
–operating position:	with sensor directed to the bottom

Electromagnetic compatibility

- Immunity to electromagnetic interference:
acc. to PN-EN 61000-6-2
- emission of electromagnetic interference:
acc. to PN-EN 61000-6-4

Safety requirements according to PN-EN 61010-1 standard

- | | |
|--------------------------------------|---------|
| –installation category | III |
| –degree of pollution | 2 |
| –operating voltage relative to earth | 50V |
| –altitude | < 2000m |

Parameters of DC power supply unit (option):

- voltage 6 V d.c. $\pm 5\%$
- maximum power 6W*
- input voltage 90...253 V a.c.
- operating temperature 0...40 °C*
- dimensions 63.6 x 29.5 x 45.6 mm*
- cord length 1.4 m $\pm 10\%$ *
- plug $\phi 5.5 / 2.1$ mm

* power supply parameters can change

8. Ordering code

Table 9

Humidity and temperature monitor HT20 type	X	X	XX	X	X
Power supply*					
6 V d.c.	1				
6 V d.c. , PoE IEEE 802.3af	2				
Accessories					
none		0			
6 V d.c. power supply unit		1			
Version					
Standard			00		
Special**			XX		
Language					
Polish				P	
English				E	
other**				X	
Acceptance tests:					
without additional requirements					0
with quality inspection certificate					1
acc. to customer's requirements					X

* - Monitor of HT20 1XXXXX version require external supply voltage of 6 V d.c. Monitors of HT20 2XXXXX version can be supplied both from Ethernet interface through PoE (Power over Ethernet), and from external power supply 6 V d.c.

** - only after agreement with the manufacturer

Coding example:

HT20-2100P1 means a monitor supplied by PoE IEEE 802.3af and 6 V d.c. with 6 V d.c. power supply unit included in standard version with Polish language version and quality inspection certificate.



LUMEL S.A.

ul. Sulechowska 1, 65-022 Zielona Góra, POLAND

tel.: +48 68 45 75 100, fax +48 68 45 75 508

www.lumel.com.pl

Export department:

tel.: (+48 68) 45 75 139, 45 75 233, 45 75 321, 45 75 386

fax.: (+48 68) 32 54 091

e-mail: export@lumel.com.pl