

IMPORTANT - CE & SAFETY REQUIREMENTS

Important - Potentially Hazardous situations. Persons responsible for the installation and operation of this equipment must be fully aware of all aspects of this guide. Failure to follow the instructions can cause severe injuries and damage.
 This product is suitable for environment Installation category II pollution degree. The product is classed as "PERMANENTLY CONNECTED EQUIPMENT", and must be DIN rail mounted, inside a suitable enclosure providing environmental protection to IP65 or greater.
 DC supply must be derived from a local supply and not a distribution system.
 To maintain CE EMC requirements, input and DC supply wires must be less than 30 metres. The product contains no serviceable parts, or internal adjustments. No attempt must be made to repair this product. Faulty units must be returned to supplier for repair. This product must be installed by a qualified person. All electrical wiring must be carried out in accordance with the appropriate regulations for the place of installation. Before attempting any electrical connection work, please ensure all supplies are switched off.

ABSOLUTE MAXIMUM CONDITIONS (To exceed may cause damage to the unit):-
 Supply Voltage ± 50 V dc (Protected for over voltage and reverse connection)
 Current with over voltage ± 200 mA
 Input Voltage ± 10 VDC, 10 V rms between any terminals
 Input Current ± 100 mA between terminals
 Ambient Temperature (-30 to 75) °C Humidity (10 to 95) % RH (Non condensing)



PLEASE REFER TO THE PRODUCT LABEL FOR MANUFACTURERS CONTACT DETAILS.

Every effort has been taken to ensure the accuracy of this document, however we do not accept responsibility for damage, injury, loss or expense resulting from errors and omissions, and we reserve the right of amendment without notice.

RECEIVE AND UNPACKING

Please inspect the packaging and instrument thoroughly for any signs of transit damage. If the instrument has been damaged, please notify your supplier immediately.

OPERATION (please refer to data sheet for full technical specification.)

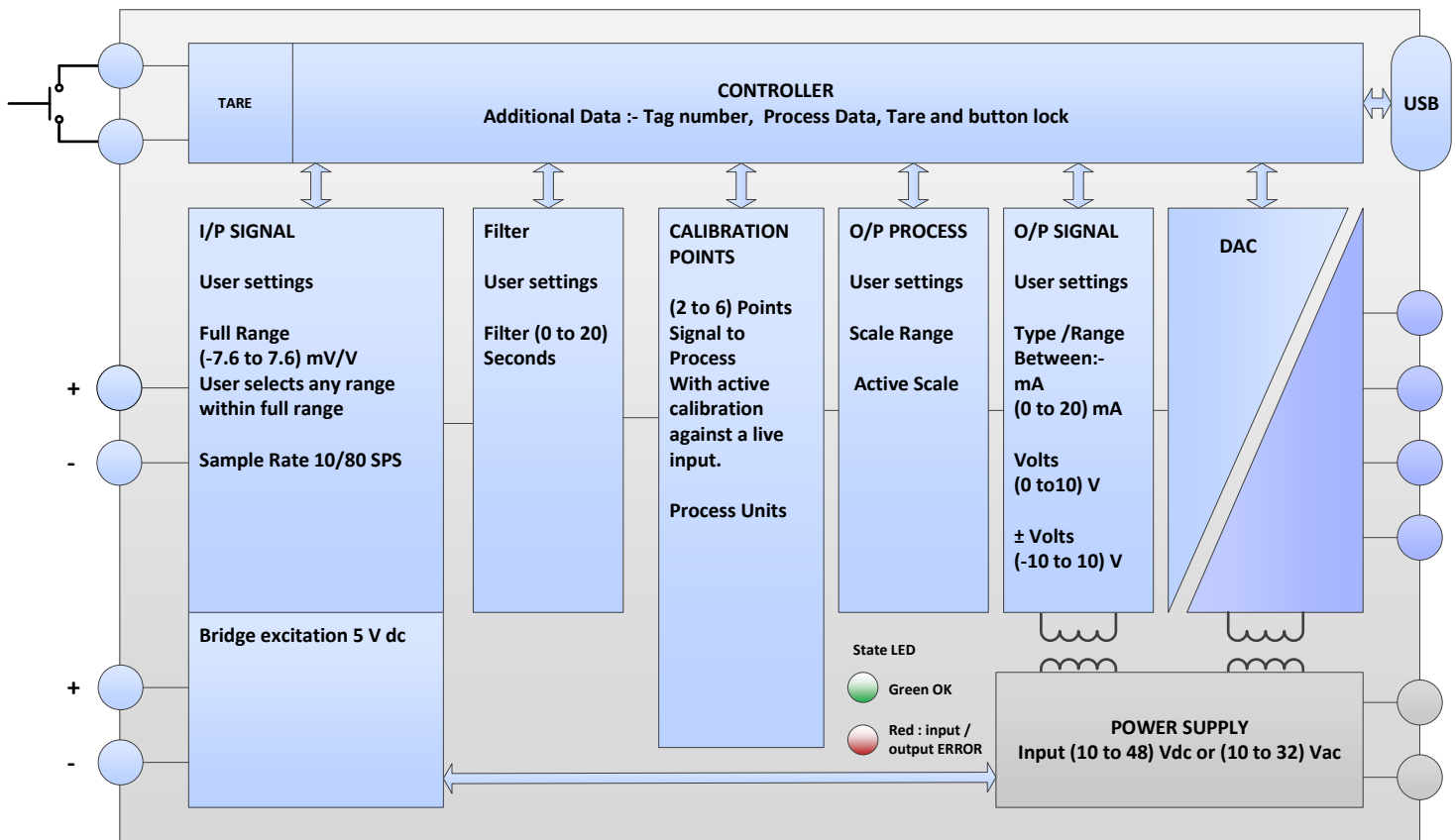

CONFIGURATION **CLICK USB_SPEEDLINK HELP BUTTON FOR FULL GUIDE TO CONFIGURATION**

This product is configured using the USB port of a PC running USB_Speed_Link software, available from your suppliers. During configuration the product is powered direct from the usb port, removing the need for additional power. If the user wishes to monitor live process data during configuration, then power must be applied. Note the input and USB port of the device share the same ground, therefore care must be taken to ensure isolation between PC and input circuit. This is best achieved by using a portable laptop or notebook PC. USB_Speed_Link software is provided with detailed help menu to guide the user through the simple configuration procedure. Unless specified at the time of order this product is supplied with the default configuration listed below.

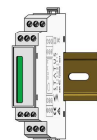

Factory default:	
Model (sensor)	= " "
Calibration Factor	= 2 mV/V
Balance	= 0.0
Sample Rate	= 10 SPS
Filter	= 0 (off)
Scale	= 2 points
Process Range	= (0 to 100)
Units	= "pV"
Process Output	= (0 to 100)
Output range	= (4 to 20) mA
Tare Setpoint	= 0.0
Tare Offset	= 0.0
Tag	= " "
Button Tare	Lock off
Adjust Buttons	Lock off

MECHANICAL INSTALLATION

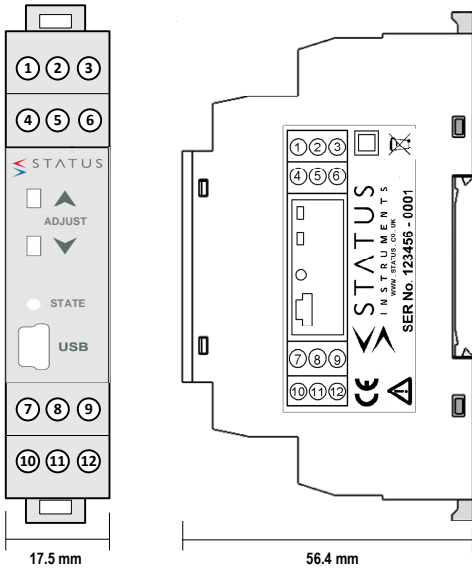

Style DIN 43880 (1 module width)
 Material Polyamide 6.6 self extinguishing
 Terminals Screw terminal
 Cable 2.5 mm Max
 Colour Grey

MOUNTING

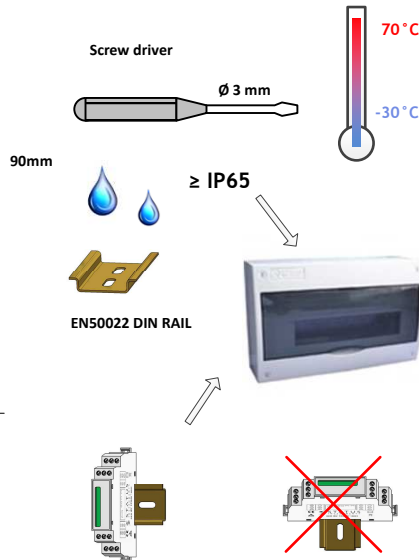

TOP

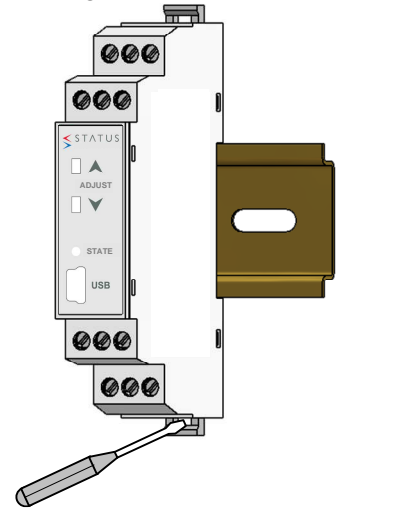

To fit or release module
 Insert screw driver into slot and lever latch away from body

ELECTRICAL INSTALLATION

- 1.0 TURN OFF SUPPLY BEFORE WORKING ON ANY ELECTRICAL CONNECTION.
- 2.0 SUPPLY IS OVER VOLTAGE PROTECTED AND FUSED WITH INTERNAL RESETTABLE FUSE.

Screened Cable



CONNECTION

For cable length < 3 Metres no screen or twist pair required.
 Use recommended types for cable length (3 to 30) metres.

Screw Driver

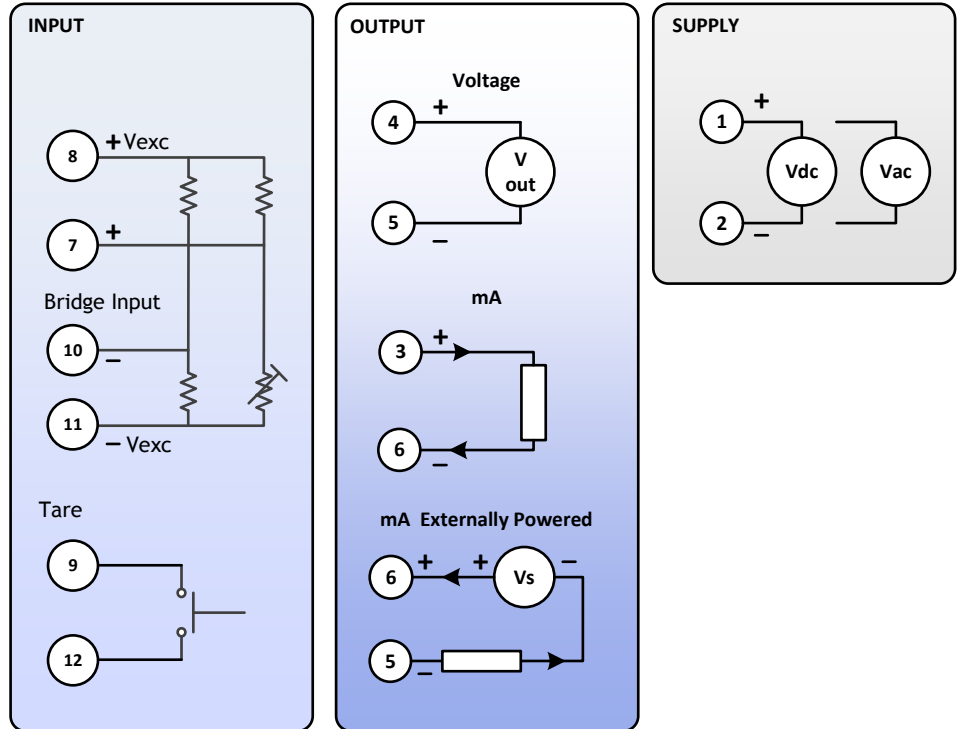
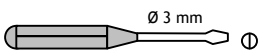

PUSH BUTTON CONFIGURATION

Two adjust buttons are provided on the front panel - blue = low adjust, red = high adjust. The adjust buttons allow the operator to adjust the device against a live input signal (similar to the "Active Range" range buttons available in the configuration software). The adjust buttons operate as follows, please note both adjust points operate independently, if desired only one adjust point may be set, for example the low (blue) to correct a zero offset :-

With the input settled at the required high or low adjust point, press and keep button pressed - the state light will go off for a few seconds then flash at a fast rate before returning to a steady state. Release button. Adjust operation complete. Output adjusts to levels preset in the software configuration.

REMOTE TARE

The tare may be set remotely by using contacts 9 and 12 connected to a volt free contact. The actual tare setpoint can be pre-programmed into the device during configuration.

On tare contact closure corrections within the device in the form of an offset are used to set the present input signal to represent the preset tare setpoint value.